











KATALOG MEBLI

SIGNAL
meble



2024



Stoły / Tables / Столы	2	
Ławy / Coffee Tables / Столики	106	
Krzeseła / Chairs / Стулья	142	
Hokery / Bar stools / Барные стулья	188	
Fotele obrotowe / Swivel chairs / Офисная мебель	190	
Biurka i regały / Desks and shelving / Столы и полки	205	
Przedpokoje i wieszaki / Hall Sets & Coat Racks / Прихожие и Вешалки	214	
Sypialnie / Bedrooms / Спальни	220	
Fotele i sofy / Armchairs and sofas / Кресла	256	
Obrazy na szkle / Glass prints / Картина на стекле	298	
Indeks / Index / Список	300	A-Z



Loreto Ceramic



Peterson Ceramic

blat: szkło hartowane+włoska ceramika Statuario Venato | top: tempered glass+italian ceramics Statuario Venato | столешница: каленое стекло+итальянская керамика Statuario Venato
 stelaż: MDF, czarny mat | frame: MDF, black mat | каркас: МДФ, черный матовый

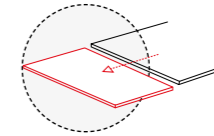

Statuario Venato
 biały mat | white mat | белый матовый



Loreto Ceramic

blat: szkło hartowane+włoska ceramika Ossido Bruno | top: tempered glass+italian ceramics Ossido Bruno | столешница: каленое стекло+итальянская керамика Ossido Bruno
 stelaż: drewno, dąb | frame: wood, oak | каркас: древесина, дуб

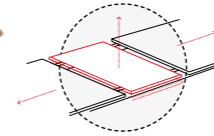

Ossido Bruno
 brąz mat | brown mat | коричневый матовый



Wilson Ceramic



Wilson Ceramic

blat: szkło hartowane+włoska ceramika Ossido Bruno | top: tempered glass+italian ceramics Ossido Bruno | столешница: каленое стекло+итальянская керамика Ossido Bruno
 stelaż: MDF, brąz antyczny | frame: MDF, antique bronze | каркас: МДФ, античная бронза

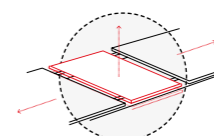

Ossido Bruno
 brąz mat | brown mat | коричневый матовый



Samanta Ceramic

blat: szkło hartowane+włoska ceramika Sahara Noir | top: tempered glass+italian ceramics Sahara Noir | столешница: каленое стекло+итальянская керамика Sahara Noir
 stelaż: metal, czarny mat | frame: metal, black mat | каркас: металл, черный матовый

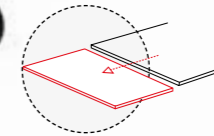
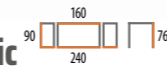

Sahara Noir
 czarny mat | black mat | черный матовый



Infinity Ceramic



Infinity Ceramic

blat: szkło hartowane+hiszpańska ceramika Nature Cloud | top: tempered glass+spanish ceramics Nature Cloud | stołешница: каленое стекло+испанская керамика Nature Cloud
 stelaż: metal, czarny mat | frame: metal, black mat | каркас: металл, черный матовый



Nature Cloud
 biały mat | white mat | белый матовый



NOWY KOLOR



Infinity Ceramic

blat: szkło hartowane+hiszpańska ceramika Amber Bianco | top: tempered glass+spanish ceramics Amber Bianco | stołешница: каленое стекло+испанская керамика Amber Bianco
 stelaż: metal, brąz | frame: metal, brown | каркас: металл, коричневый



Amber Bianco
 biały mat | white mat | белый матовый



Infinity Ceramic



Infinity Ceramic

blat: szkło hartowane+hiszpańska ceramika Azario Black | top: tempered glass+spanish ceramics Azario Black | stołешница: каленое стекло+испанская керамика Azario Black
 stelaż: metal, czarny mat | frame: metal, black mat | каркас: металл, черный матовый



Azario Black
 czarny mat | black mat | черный матовый



Avangard II Ceramic

blat: szkło hartowane+ceramika Noir Laurent | top: tempered glass+ceramics Noir Laurent | stołешница: каленое стекло+керамика Noir Laurent
 stelaż: metal, czarny mat | frame: metal, black mat | каркас: металл, черный матовый



Noir Laurent
 czarny mat | black mat | черный матовый





Moncler Ceramic



Moncler Ceramic



blat: szkło hartowane+włoska ceramika Verde Alpi | top: tempered glass+italian ceramics Verde Alpi | столешница: каленое стекло+итальянская керамика Verde Alpi
 stelaż: metal, stal nierdzewna | frame: metal, stainless steel | каркас: металл, нержавеющая сталь

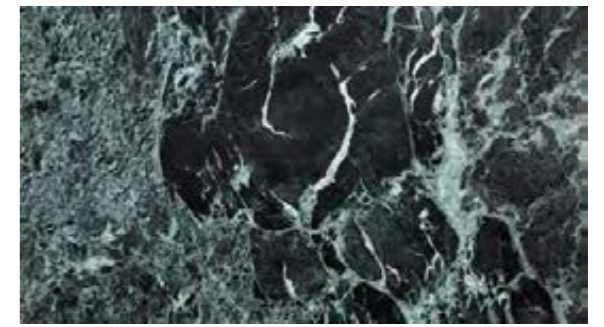

Verde Alpi
 morski | sea blue | бирюзовый



Moncler Ceramic



blat: szkło hartowane+włoska ceramika Sahara Noir | top: tempered glass+italian ceramics Sahara Noir | столешница: каленое стекло+итальянская керамика Sahara Noir
 stelaż: metal, stal nierdzewna | frame: metal, stainless steel | каркас: металл, нержавеющая сталь



Sahara Noir
 czarny mat | black mat | черный матовый



Moncler Ceramic



April Vardo



Diuna Ceramic



blat: szkło hartowane+włoska ceramika Pietra di Savoia | top: tempered glass+italian ceramics Pietra di Savoia | столешница: каленое стекло+итальянская керамика Pietra di Savoia
 stelaż: metal, czarny mat | frame: metal, black mat | каркас: металл, черный матовый



Pietra di Savoia
 jasny szary mat | light grey mat | светлый серый матовый



Diuna



blat: szkło hartowane | top: tempered glass | столешница: каленое стекло
 stelaż: metal, czarny mat | frame: metal, black mat | каркас: металл, черный матовый

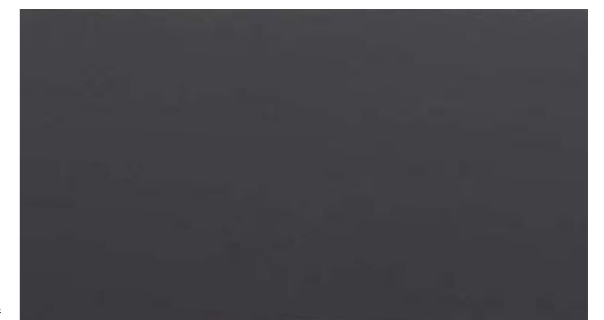

szkło hartowane | tempered glass | каленое стекло
 czarny mat | black mat | черный матовый



Diuna Ceramic



Diuna Ceramic

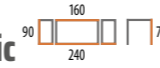

blat: szkło hartowane+ włoska ceramika Sahara Noir | top: tempered glass+italian ceramics Sahara Noir | столешница: каленое стекло+итальянская керамика Sahara Noir
 stelaż: metal, czarny mat | frame: metal, black mat | каркас: металл, черный матовый



Sahara Noir
 czarny mat | black mat | черный матовый



Diuna Ceramic



blat: szkło hartowane+ włoska ceramika Noir Desire | top: tempered glass+italian ceramics Noir Desire | столешница: каленое стекло+итальянская керамика Noir Desire
 stelaż: metal, czarny mat | frame: metal, black mat | каркас: металл, черный матовый



Noir Desire
 czarny mat | black mat | черный матовый



Diuna Ceramic



Diuna Ceramic



blat: szkło hartowane+ włoska ceramika Statuario Venato | top: tempered glass+italian ceramics Statuario Venato | столешница: итальянская керамика Statuario Venato
 stelaż: metal, czarny mat | frame: metal, black mat | каркас: металл, черный матовый



Statuario Venato
 biały mat | white mat | белый матовый



Diuna Ceramic



blat: szkło hartowane+ włoska ceramika Ossido Bruno | top: tempered glass+italian ceramics Ossido Bruno | столешница: каленое стекло+итальянская керамика Ossido Bruno
 stelaż: metal, czarny mat | frame: metal, black mat | каркас: металл, черный матовый



Ossido Bruno
 brąz mat | brown mat | коричневый матовый



Westin Ceramic



Westin Ceramic

blat: szkło hartowane+ włoska ceramika Sahara Noir | top: tempered glass+italian ceramics Sahara Noir | столешница: каленое стекло+итальянская керамика Sahara Noir
 stelaż: metal, czarny mat | frame: metal, black mat | каркас: металл, черный матовый

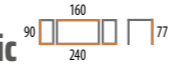

Sahara Noir
 czarny mat | black mat | черный матовый



Westin Ceramic

blat: szkło hartowane+ włoska ceramika Ossido Verde | top: tempered glass+italian ceramics Ossido Verde | столешница: каленое стекло+итальянская керамика Ossido Verde
 stelaż: metal, czarny mat | frame: metal, black mat | каркас: металл, черный матовый

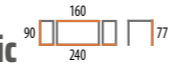

Ossido Verde
 turkus mat | turquoise mat | бирюзовый матовый



Westin Ceramic



Westin Ceramic

blat: szkło hartowane+ włoska ceramika Diamond Cream | top: tempered glass+italian ceramics Diamond Cream | столешница: каленое стекло+итальянская керамика Diamond Cream
 stelaż: metal, czarny mat | frame: metal, black mat | каркас: металл, черный матовый

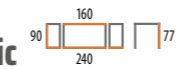

NOWY KOLOR



Diamond Cream
 krem mat | cream mat | кремовый матовый



Westin Ceramic

blat: szkło hartowane+ włoska ceramika Ossido Bruno | top: tempered glass+italian ceramics Ossido Bruno | столешница: каленое стекло+итальянская керамика Ossido Bruno
 stelaż: metal, czarny mat | frame: metal, black mat | каркас: металл, черный матовый

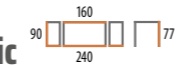

NOWY KOLOR



Ossido Bruno
 brąz mat | brown mat | коричневый матовый



Westin Ceramic



Westin Ceramic

blat: szkło hartowane+ włoska ceramika Pietra di Savoia | top: tempered glass+italian ceramics Pietra di Savoia | столешница: каленое стекло+итальянская керамика Pietra di Savoia
 stelaż: metal, czarny mat | frame: metal, black mat | каркас: металл, черный матовый



NOWY KOLOR



Pietra di Savoia
 jasny szary mat | light grey mat | светлый серый матовый



Westin Ceramic

blat: szkło hartowane+ włoska ceramika Sabbia | top: tempered glass+italian ceramics Sabbia | столешница: каленое стекло+итальянская керамика Sabbia
 stelaż: metal, czarny mat | frame: metal, black mat | каркас: металл, черный матовый



NOWY KOLOR



Sabbia
 jasny brąz mat | light brown mat | светлый коричневый матовый



Westin Ceramic

blat: szkło hartowane+ hiszpańska ceramika Legno | top: tempered glass+spanish ceramics Legno | столешница: каленое стекло+испанская керамика Legno
 stelaż: metal, czarny mat | frame: metal, black mat | каркас: металл, черный матовый

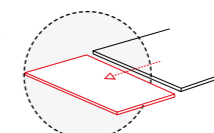

Legno
 brąz mat | brown mat | коричневый матовый



Westin III Ceramic

blat: szkło hartowane+ włoska ceramika Statuario Venato | top: tempered glass+italian ceramics Statuario Venato | столешница: каленое стекло+итальянская керамика Statuario Venato
 stelaż: metal, czarny mat | frame: metal, black mat | каркас: металл, черный матовый

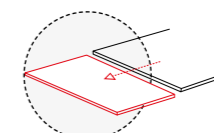

Statuario Venato
 biały mat | white mat | белый матовый



Westin III Ceramic



Westin I



Westin Ceramic

blat: szkło hartowane+ włoska ceramika Verde Alpi | top: tempered glass+italian ceramics Verde Alpi | столешница: каленое стекло+итальянская керамика Verde Alpi
 stelaż: metal, czarny mat | frame: metal, black mat | каркас: металл, черный матовый

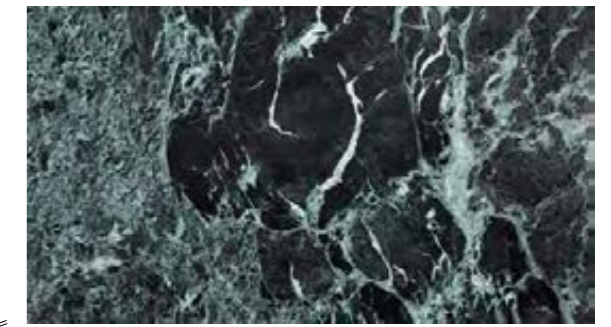

Verde Alpi
 morski | sea blue | бирюзовый



Westin Ceramic

blat: szkło hartowane+ włoska ceramika Noir Desire | top: tempered glass+italian ceramics Noir Desire | столешница: каленое стекло+итальянская керамика Noir Desire
 stelaż: metal, czarny mat | frame: metal, black mat | каркас: металл, черный матовый



Noir Desire
 czarny mat | black mat | черный матовый



Westin SG



Westin I

blat: szkło hartowane | top: tempered glass | столешница: каленое стекло
 stelaż: metal, czarny mat | frame: metal, black mat | каркас: металл, черный матовый



szkło hartowane | tempered glass | каленое стекло
 czarny mat | black mat | черный матовый



Westin SG

blat: szkło hartowane | top: tempered glass | столешница: каленое стекло
 stelaż: metal, czarny mat | frame: metal, black mat | каркас: металл, черный матовый



szkło hartowane | tempered glass | каленое стекло
 czarny mat | black mat | черный матовый



Westin SG

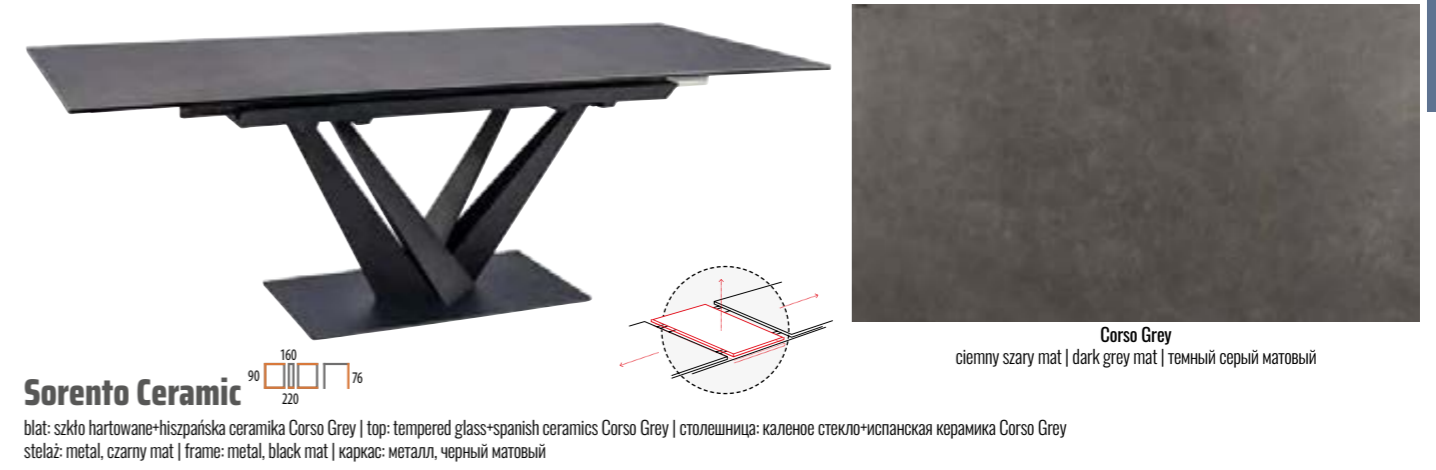
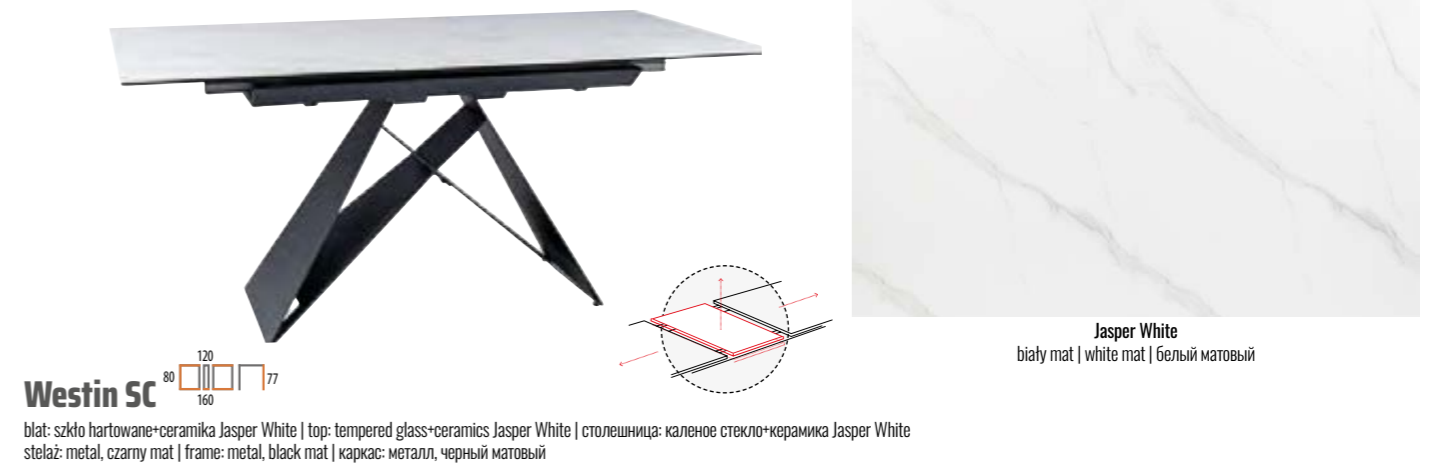

Sorento Ceramic





Salvadore Ceramic



Salvadore Ceramic



Legno
brąz mat | brown mat | коричневый матовый

Salvadore Ceramic

blat: szkło hartowane+hiszpańska ceramika Legno | top: tempered glass+spanish ceramics Legno | столешница: каленое стекло+испанская керамика Legno
stelaż: metal, czarny mat | frame: metal, black mat | каркас: металл, черный матовый

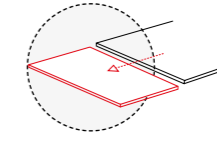

Ossido Verde
turkus mat | turquoise mat | бирюзовый матовый

Salvadore Ceramic

blat: szkło hartowane+włoska ceramika Ossido Verde | top: tempered glass+italian ceramics Ossido Verde | столешница: каленое стекло+итальянская керамика Ossido Verde
stelaż: metal, czarny mat | frame: metal, black mat | каркас: металл, черный матовый

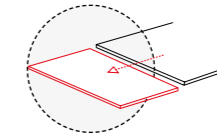

Ossido Bruno
brąz mat | brown mat | коричневый матовый

Salvadore Ceramic

blat: szkło hartowane+włoska ceramika Ossido Bruno | top: tempered glass+italian ceramics Ossido Bruno | столешница: каленое стекло+итальянская керамика Ossido Bruno
stelaż: metal, czarny mat | frame: metal, black mat | каркас: металл, черный матовый

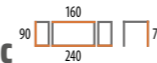

NOWY KOLOR

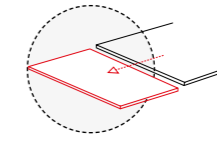

Salvadore Ceramic



Diamond Cream
krem mat | cream mat | кремовый матовый

Salvadore Ceramic

blat: szkło hartowane+włoska ceramika Diamond Cream | top: tempered glass+italian ceramics Diamond Cream | столешница: каленое стекло+итальянская керамика Diamond Cream
stelaż: metal, czarny mat | frame: metal, black mat | каркас: металл, черный матовый

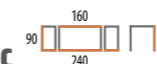

NOWY KOLOR

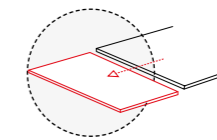



Salvadore Ceramic

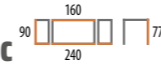

Salvadore Ceramic

NOWY KOLOR

blat: szkło hartowane+włoska ceramika Pietra di Savoia | top: tempered glass+italian ceramics Pietra di Savoia | столешница: каленое стекло+итальянская керамика Pietra di Savoia
 stelaż: metal, czarny mat | frame: metal, black mat | каркас: металл, черный матовый

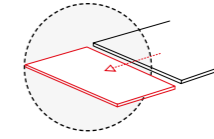

Pietra di Savoia
 jasny szary mat | light grey mat | светлый серый матовый

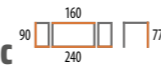

Salvadore Ceramic

NOWY KOLOR

blat: szkło hartowane+włoska ceramika Sahara Noir | top: tempered glass+italian ceramics Sahara Noir | столешница: каленое стекло+итальянская керамика Sahara Noir
 stelaż: metal, czarny mat | frame: metal, black mat | каркас: металл, черный матовый

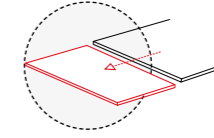

Sahara Noir
 czarny mat | black mat | черный матовый



Salvadore Melted Glass

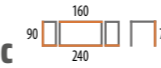

Salvadore Ceramic

NOWY KOLOR

blat: szkło hartowane+włoska ceramika Verde Alpi | top: tempered glass+italian ceramics Verde Alpi | столешница: каленое стекло+итальянская керамика Verde Alpi
 stelaż: metal, czarny mat | frame: metal, black mat | каркас: металл, черный матовый

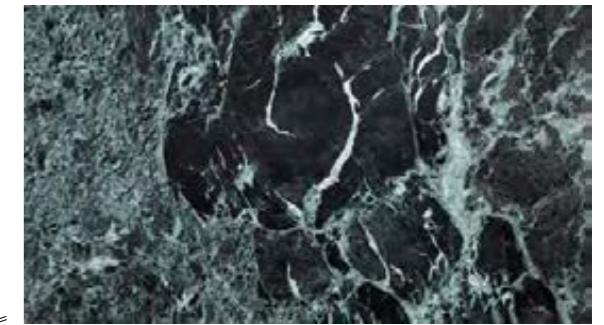
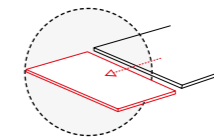

Verde Alpi
 morski | sea blue | бирюзовый

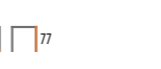

Salvadore

blat: szkło hartowane Melted Glass | top: tempered glass Melted Glass | столешница: каленое стекло Melted Glass
 stelaż: metal, czarny mat | frame: metal, black mat | каркас: металл, черный матовый

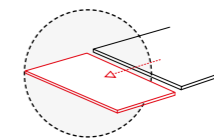

Melted Glass
 czarny połysk | black high gloss | черный лак



Salvadore Ceramic



Salvadore Ceramic

blat: szkło hartowane+ włoska ceramika Anthracite | top: tempered glass+italian ceramics Anthracite | столешница: каленое стекло+итальянская керамика Anthracite
 stelaż: metal, czarny mat | frame: metal, black mat | каркас: металл, черный матовый

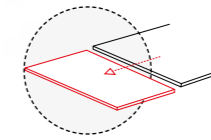

Anthracite
szary mat | grey mat | серый матовый



Salvadore

blat: szkło hartowane | top: tempered glass | столешница: каленое стекло
 stelaż: metal, czarny mat | frame: metal, black mat | каркас: металл, черный матовый

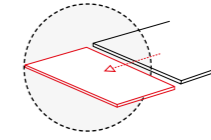

szkło hartowane | tempered glass | каленое стекло
czarny mat | black mat | черный матовый



Salvadore



Salvadore Ceramic

blat: szkło hartowane+ włoska ceramika Sabbia | top: tempered glass+italian ceramics Sabbia | столешница: каленое стекло+итальянская керамика Sabbia
 stelaż: metal, czarny mat | frame: metal, black mat | каркас: металл, черный матовый

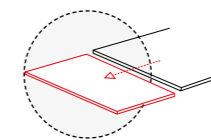

Sabbia
jasny brąz mat | light brown mat | светлый коричневый матовый



Salvadore II Ceramic

blat: szkło hartowane+hiszpańska ceramika Corso Grey | top: tempered glass+spanish ceramics Corso Grey | столешница: каленое стекло+испанская керамика Corso Grey
 stelaż: metal, czarny mat | frame: metal, black mat | каркас: металл, черный матовый

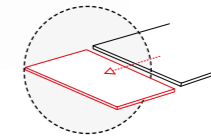
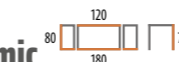

Corso Grey
ciemny szary mat | dark grey mat | темный серый матовый



Logan



Logan



blat: MDF+okleina naturalna | top: MDF+natural veneer | столешница: МДФ+натуральный шпон
stelaż: metal, czarny mat | frame: metal, black mat | каркас: металл, орех / черный матовый



orzech | walnut | орех



Logan

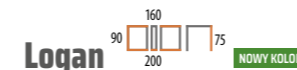

blat: MDF+okleina naturalna | top: MDF+natural veneer | столешница: МДФ+натуральный шпон
stelaż: metal, czarny mat | frame: metal, black mat | каркас: металл, орех / черный матовый



dąb | oak | дуб



Logan Ceramic



Logan Ceramic



blat: MDF+ceramika | top: MDF+ceramics | столешница: МДФ+керамика
stelaż: metal, czarny mat | frame: metal, black mat | каркас: металл, орех / черный матовый



biały mat | white mat | белый матовый



Capitol



blat: MDF+okleina | top: MDF+veneer | столешница: МДФ+шпон
stelaż: metal, czarny mat | frame: metal, black mat | каркас: металл, черный матовый



dąb | oak | дуб



Genesis

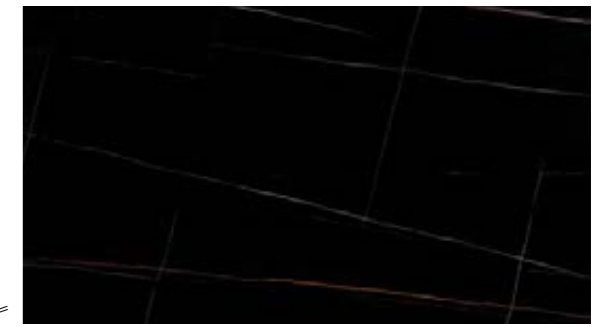

czarny mat | black mat | черный матовый

Genesis



blat: ceramika, efekt marmuru | top: ceramics, marble effect | столешница: керамика, эффект мрамора
 stelaż: MDF+okleina+metal, jesion+czarny mat | frame: MDF+ veneer+metal, ash wood+black mat | каркас: МДФ+шпон+металл / ясень+черный матовый



biały mat | white mat | белый матовый

Genesis



blat: ceramika, efekt marmuru | top: ceramics, marble effect | столешница: керамика, эффект мрамора
 stelaż: MDF+okleina+metal, dąb+czarny mat | frame: MDF+ veneer+metal, oak wood+black mat | каркас: МДФ+шпон+металл, дуб+черный матовый



Columbus Ceramic



Legno
 brąz mat | brown mat | коричневый матовый

Columbus Ceramic



blat: szkło hartowane+hiszpańska ceramika Legno | top: tempered glass+spanish ceramics Legno | столешница: каленое стекло+испанская керамика Legno
 stelaż: metal, czarny mat | frame: metal, black mat | каркас: металл, черный матовый



Amber Bianco
 biały mat | white mat | белый матовый

Columbus Ceramic



blat: szkło hartowane+hiszpańska ceramika Amber Bianco | top: tempered glass+spanish ceramics Amber Bianco | столешница: испанская керамика Amber Bianco
 stelaż: metal, czarny mat | frame: metal, black mat | каркас: металл, черный матовый



Bonucci Ceramic

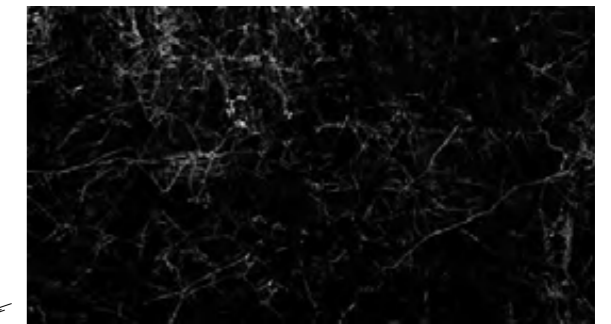

Nero Greco
czarny mat | black mat | черный матовый

Bonucci Ceramic

blat: szkło hartowane+wfloska ceramika Nero Greco | top: tempered glass+italian ceramics Nero Greco | столешница: итальянская керамика Nero Greco
stelaż: MDF+okleina naturalna, orzech | frame: MDF+natural veneer, walnut | каркас: МДФ+нат. шпон, орех

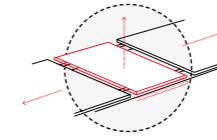

Statuario Venato
biały mat | white mat | белый матовый

Bonucci Ceramic

blat: szkło hartowane+wfloska ceramika Statuario Venato | top: tempered glass+italian ceramics Statuario Venato | столешница: итальянская керамика Statuario Venato
stelaż: MDF+okleina naturalna, orzech | frame: MDF+natural veneer, walnut | каркас: МДФ+нат. шпон, орех



NOWY KOLOR

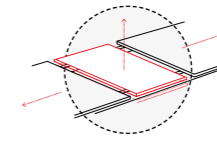

Dolce Ceramic



Italy Grey
szary mat | grey mat | серый матовый

Dolce Ceramic

blat: szkło hartowane+wfloska ceramika Italy Grey | top: tempered glass+italian ceramics Italy Grey | столешница: итальянская керамика Italy Grey
stelaż: MDF+okleina, dąb | frame: MDF+veneer, oak | каркас: МДФ+шпон, дуб

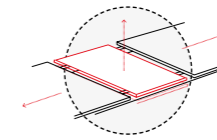

Pietra di Savoia
jasny szary mat | light grey mat | светлый серый матовый

Dolce Ceramic

blat: szkło hartowane+wfloska ceramika Pietra di Savoia | top: tempered glass+italian ceramics Pietra di Savoia | столешница: итальянская керамика Pietra di Savoia
stelaż: MDF+okleina, dąb | frame: MDF+veneer, oak | каркас: МДФ+шпон, дуб



NOWY KOLOR

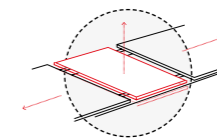



Armani Ceramic



Armani Ceramic



Alaras III



Armani Ceramic

blat: szkło hartowane+włoska ceramika Statuario Venato | top: tempered glass+italian ceramics Statuario Venato | столешница: каленое стекло+итальянская керамика Statuario Venato
 stelaż: MDF+metal, czarny mat+stal szcztokowana | frame: MDF+metal, black mat+brushed steel | каркас: МДФ+металл, черный матовый+матовая сталь



Statuario Venato
 biały mat | white mat | белый матовый



Armani Ceramic

blat: MDF+ceramika, efekt marmuru | top: MDF+ceramics, marble effect | столешница: МДФ+керамика, эффект мрамора
 stelaż: MDF+metal, szary mat+stal szcztokowana | frame: MDF+metal, grey mat+brushed steel | каркас: МДФ+металл, серый матовый+матовая сталь



szary mat | grey mat | серый матовый



Armani

blat: MDF+szkło hartowane | top: MDF+tempered glass | столешница: МДФ+каленое стекло
 stelaż: MDF+szkło, biały mat | frame: MDF+glass, white mat | каркас: МДФ+стекло, белый матовый

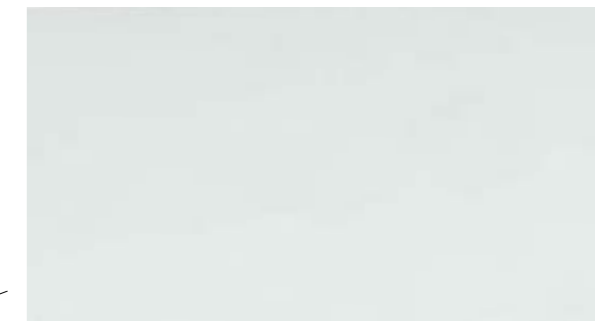

biały mat | white mat | белый матовый



Alaras III

blat: MDF+szkło hartowane | top: MDF+tempered glass | столешница: МДФ+каленое стекло
 stelaż: MDF+stal szcztokowana, biały | frame: MDF+brushed steel, white | каркас: МДФ+матовая сталь, белый



biały lakier | white high gloss | белый лак



Cortez Ceramic

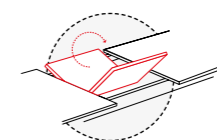

szary połysk | grey high gloss | серый лак

Cortez Ceramic

blat: MDF+ceramika, efekt marmuru | top: MDF+ceramics, marble effect | столешница: МДФ+керамика, эффект мрамора
 stelaż: MDF+stal szcztokowana, antracyt mat | frame: MDF+brushed steel, anthracite mat | каркас: МДФ+матовая сталь, матовый антрацит

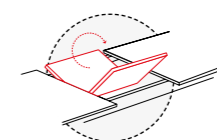

Jasper White
 biały mat | white mat | белый матовый

Saturn II Ceramic

blat: MDF+ceramika Jasper White, efekt marmuru | top: MDF+ceramics Jasper White, marble effect | столешница: МДФ+керамика Jasper White, эффект мрамора
 stelaż: MDF+stal szcztokowana, biały mat | frame: MDF+brushed steel, white mat | каркас: МДФ+матовая сталь, матовый белый



Saturn II Ceramic

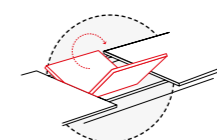

szary połysk | grey high gloss | серый лак

Pallas Ceramic

blat: MDF+ceramika, efekt marmuru | top: MDF+ceramics, marble effect | столешница: МДФ+керамика, эффект мрамора
 stelaż: MDF+stal szcztokowana, czarny mat | frame: MDF+brushed steel, black mat | каркас: МДФ+матовая сталь, черный матовый

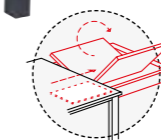

Nero
 czarny mat | black mat | черный матовый

Metropol Ceramic

blat: szkło hartowane+ceramika Nero | top: tempered glass+ceramics Nero | столешница: каленое стекло+керамика Nero
 stelaż: metal, czarny mat | frame: metal, black mat | каркас: металл, черный матовый





Leonardo



Leonardo

blat: MDF+szkło hartowane | top: MDF+tempered glass | столешница: МДФ+каленное стекло
 stelaż: stal nierdzewna | frame: stainless steel | каркас: нержавеющая сталь

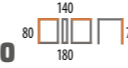

biały połysk | white high gloss | белый лак



Leonardo

blat: MDF+okleina, efekt betonu | top: MDF+veneer, concrete effect | столешница: МДФ+шпон, эффект бетона
 stelaż: MDF+okleina+szkło | frame: MDF+veneer+glass | каркас: МДФ+шпон+стекло



szary | grey | серый



Leonardo



Leonardo

blat: MDF+okleina | top: MDF+veneer | столешница: МДФ+шпон
 stelaż: MDF+okleina+szkło | frame: MDF+veneer+glass | каркас: МДФ+шпон+стекло



dąb | oak | дуб



Dallas

blat: MDF | top: MDF | столешница: МДФ+шпон
 stelaż: MDF+metal | frame: MDF+metal | каркас: МДФ+металл



biały lakier | white high gloss | белый лак



Umberto II



Umberto II 90 160 160+40+40 76 N

blat: MDF+okleina | top: MDF+veneer | столешница: МДФ+шпон
stelaż: metal, czarny mat | frame: metal, black mat | каркас: металл, черный матовый

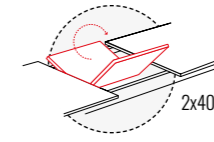

dąb artisan | artisan oak | дуб артисан



Xaviero II 90 160 160+40+40 76 N

blat: MDF+okleina | top: MDF+veneer | столешница: МДФ+шпон
stelaż: metal, czarny mat | frame: metal, black mat | каркас: металл, черный матовый

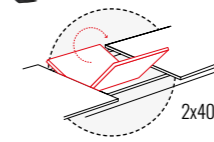

dąb artisan | artisan oak | дуб артисан



Xaviero II

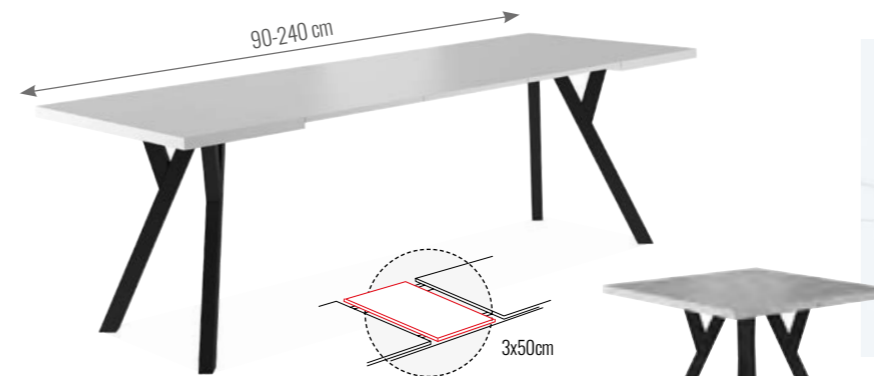

Merlin 90 90 90+50+50+50 76

blat: płyta laminowana | top: laminated board | столешница: ламин. ДСП
stelaż: metal, czarny mat | frame: metal, black mat | каркас: металл, черный матовый

wkładka przechowywana osobno



biały mat | white mat | белый матовый efekt betonu | concrete effect | эффект бетона



Giotto 60 110 11+76

blat: MDF+okleina naturalna jesionowa | top: MDF+natural ash veneer | столешница: МДФ+натуральный шпон ясеня
stelaż: metal, czarny mat | frame: metal, black mat | каркас: металл, черный матовый



jesion | ash | ясень



Cross



150 90 79 180 90 79 150 90 79



okleina naturalna
natural veneer
нат. шпон

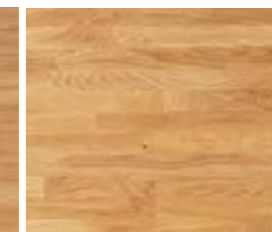

lite drewno dębowe
solid oak wood
массив дуба

Cross / Cross dąb

blat: lite drewno dębowe / okleina naturalna | top: solid oak wood / natural veneer | stol.: массив дуба / нат. шпон | stelaż: metal, czarny mat | frame: metal, black mat | каркас: металл, черный матовый



150 90 79 180 90 79 150 90 79



okleina naturalna
natural veneer
нат. шпон

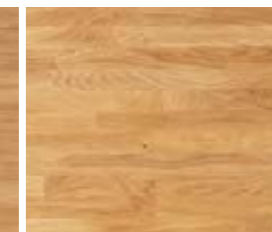

lite drewno dębowe
solid oak wood
массив дуба

Umberto / Umberto dąb

blat: lite drewno dębowe / okleina naturalna | top: solid oak wood / natural veneer | stol.: массив дуба / нат. шпон | stelaż: metal, czarny mat | frame: metal, black mat | каркас: металл, черный матовый



Falcon



okleina naturalna
natural veneer
нат. шпон

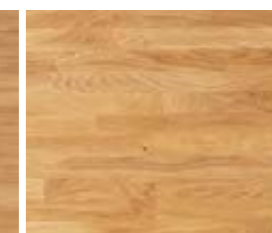

lite drewno dębowe
solid oak wood
массив дуба

Falcon / Falcon dąb

blat: lite drewno dębowe / okleina naturalna | top: solid oak wood / natural veneer | stol.: массив дуба / нат. шпон | stelaż: metal, czarny mat | frame: metal, black mat | каркас: металл, черный матовый



hoker / bar stool / барный стул



okleina naturalna
natural veneer
нат. шпон

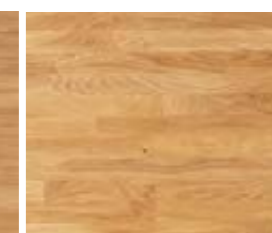

lite drewno dębowe
solid oak wood
массив дуба

Metro / Metro dąb

okleina naturalna / lite drewno dębowe | natural veneer / solid oak wood | нат. шпон / массив дуба
metal, czarny mat | metal, black mat | металл, черный матовый

110 60 100 75 35 35 71



Fresno



Fresno



Fresno

80 120 180 76 90 150 210 76

blat: MDF+okleina | top: MDF+veneer | столешница: МДФ+шпон
stelaż: metal, czarny mat | frame: metal, black mat | каркас: металл, черный матовый

wkładka przechowywana osobno

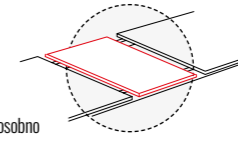

dąb | oak | дуб



Fresno

80 120 180 76 90 150 210 76

blat: MDF+okleina | top: MDF+veneer | столешница: МДФ+шпон
stelaż: metal, czarny mat | frame: metal, black mat | каркас: металл, черный матовый

wkładka przechowywana osobno

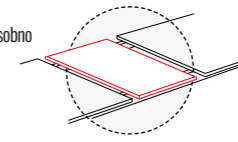

dąb artisan | artisan oak | дуб артисан



Brick



Vito

85 140 180 76

blat: MDF+okleina | top: MDF+veneer | столешница: МДФ+шпон
stelaż: metal, czarny mat | frame: metal, black mat | каркас: металл, черный матовый

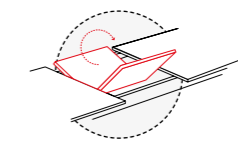

dąb artisan | artisan oak | дуб артисан



Brick

80 120 160 75

blat: MDF+okleina | top: MDF+veneer | столешница: МДФ+шпон
stelaż: metal, czarny mat | frame: metal, black mat | каркас: металл, черный матовый

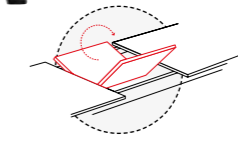

dąb artisan | artisan oak | дуб артисан



Timber



Timber

blat: MDF+okleina | top: MDF+veneer | stołeshnica: МДФ+шпон
 stelaż: metal, dąb | frame: metal, oak | каркас: металл, дуб

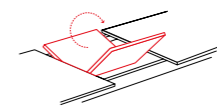

dąb | oak | дуб



Brando

blat: MDF+okleina naturalna | top: MDF+natural veneer | stołeshnica: МДФ+нат. шпон
 stelaż: drewno, dąb | frame: wood, oak | каркас: древесина, дуб

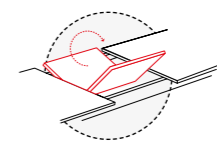

dąb | oak | дуб



Remus II



Remus II

blat: MDF+okleina | top: MDF+veneer | stołeshnica: МДФ+шпон
 stelaż: metal, czarny mat | frame: metal, black mat | каркас: металл, черный матовый

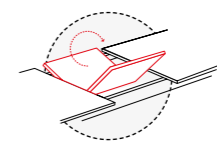

orzech vintage | vintage walnut | винтажный орех



orzech | walnut | орех



dąb | oak | дуб

Remus

blat: MDF laminowany | top: laminated MDF | stołeshnica: ламин. МДФ
 stelaż: metal, czarny mat | frame: metal, black mat | каркас: металл, черный матовый





Rene



Rene 90 160 200 76 N

blat: MDF+melamina, efekt marmuru | top: MDF+melamine finish, marble effect | столешница: МДФ+меламин, эффект мрамора
 stelaż: metal, czarny mat | frame: metal, black mat | каркас: металл, черный матовый

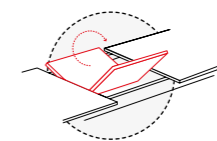

szary | grey | серый



Rene 90 160 200 76 N

blat: MDF+okleina | top: MDF+veneer | столешница: МДФ+шпон
 stelaż: metal, czarny mat | frame: metal, black mat | каркас: металл, черный матовый

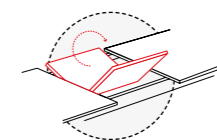

dąb | oak | дуб



Rene



Bari 80 120 160 76 N

blat: MDF+okleina, efekt marmuru | top: MDF+veneer, marble effect | столешница: МДФ+шпон, мраморный эффект
 stelaż: metal, czarny mat | frame: metal, black mat | каркас: металл, черный матовый

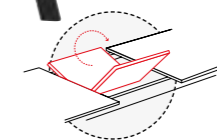

biały | white | белый



Bari 80 120 160 76 N

blat: MDF+okleina | top: MDF+veneer | столешница: МДФ+шпон
 stelaż: metal, czarny mat | frame: metal, black mat | каркас: металл, черный матовый

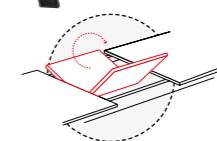

dąb artisan | artisan oak | дуб артисан



John



John 85 120 180 76 90 150 210 76 **NOWY WYMIAR**
 blat: ceramika, efekt marmuru | top: ceramics, marble effect | столешница: керамика, эффект мрамора
 stelaż: metal, czarny mat | frame: metal, black mat | каркас: металл, черный матовый



biały połysk | white high gloss | белый лак



Apollo 80 120 160 76 90 150 190 76 **NOWY WYMIAR**
 blat: ceramika, efekt marmuru | top: ceramics, marble effect | столешница: керамика, эффект мрамора
 stelaż: drewno, czarny mat | frame: wood, black mat | каркас: древесина, черный матовый



biały mat | white mat | белый матовый



Ivy



Rion 70 130 160 75 90 75
 blat: ceramika, efekt marmuru | top: ceramics, marble effect | столешница: керамика, эффект мрамора
 stelaż: metal, czarny mat | frame: metal, black mat | каркас: металл, черный матовый



biały połysk | white high gloss | белый лак



Ivy 80 140 75
 blat: ceramika, efekt marmuru | top: ceramics, marble effect | столешница: керамика, эффект мрамора
 stelaż: metal, czarny mat | frame: metal, black mat | каркас: металл, черный матовый



szary połysk | grey high gloss | серый лак



Cyryl I



szary | grey | серый

Cyryl I 140 80 75

blat: MDF+szkło hartowane, efekt kamienia | top: MDF+tempered glass, stone effect | столешница: МДФ+каленное стекло, эффект мрамора
 stelaż: metal, czarny mat+złoty | frame: metal, black mat+golden | каркас: металл, черный матовый+золотой



biały | white | белый

Samuel 120 80 75

blat: MDF+szkło hartowane, efekt marmuru | top: MDF+tempered glass, marble effect | столешница: МДФ+каленное стекло, эффект мрамора
 stelaż: metal, czarny mat | frame: metal, black mat | каркас: металл, черный матовый



Samuel



szkło transparentne | transparent glass | прозрачное стекло

Agis II 140 80 75

blat: szkło hartowane | top: tempered glass | столешница: каленое стекло
 stelaż: metal, chrom | frame: metal, chrome | каркас: металл, хром



Agis II



Madras 90 60 75

blat: szkło hartowane transparentne | top: transparent tempered glass | стол: прозрачное каленое стекло
 stelaż: metal, chrom | frame: metal, chrome | каркас: металл, хром

Finezja A 90 77

blat: szkło hartowane transparentne | top: transparent tempered glass | стол: прозрачное каленое стекло
 stelaż: metal, chrom | frame: metal, chrome | каркас: металл, хром



Prince Ceramic



Prince



Calacatta
biały połysk | white high gloss | белый лак

Prince Ceramic 90 150 75 90 180 75

blat: ceramika Calacatta | top: ceramics Calacatta | стол: керамика Calacatta
stelaż: stal nierdzewna, chrom | frame: stainless steel, chrome | каркас: нержавеющая сталь, хром

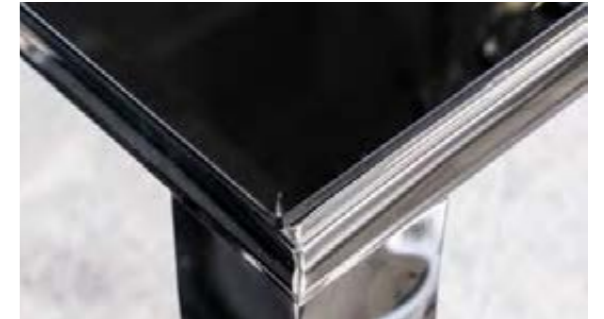

szkło hartowane | tempered glass | каленое стекло
czarny | black | черный

Prince 90 150 75 90 180 75

blat: szkło hartowane | top: tempered glass | столешница: каленое стекло
stelaż: stal nierdzewna, chrom | frame: stainless steel, chrome | каркас: нержавеющая сталь, хром



Prince B Ceramic 55 55 55
tawa / coffee table / столик

Prince A Ceramic 60 120 45
tawa / coffee table / столик

Prince C Ceramic 40 120 78
konsolka / console table / консоль



Prince B 55 55 55
tawa / coffee table / столик

Prince A 60 120 45
tawa / coffee table / столик

Prince C 40 120 78
konsolka / console table / консоль



Hermes Ceramic



biały połysk | white high gloss | белый лак

Hermes 90 160 75

blat: ceramika, efekt marmuru | top: ceramics, marble effect | столешница: керамика, эффект мрамора
stelaż: stal nierdzewna, złoty | frame: stainless steel, golden | каркас: нержавеющая сталь, золотой



czarny 19 | black 19



beż 28 | beige 28

Queen Velvet 111 46 53 49

tkanina aksamit: Bluvel | velvet fabric: Bluvel | ткань бархат: Bluvel
stal nierdzewna, złoty | stainless steel, golden | нержавеющая сталь, золотой



czarny 19 | black 19



beż 28 | beige 28

King Velvet 95 43 47 48

tkanina aksamit: Bluvel | velvet fabric: Bluvel | ткань бархат: Bluvel
stal nierdzewna, złoty | stainless steel, golden | нержавеющая сталь, золотой



Azalia Ceramic

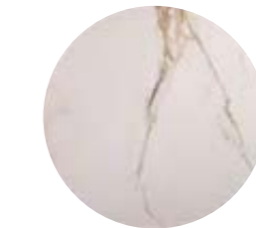

biały połysk | white high gloss | белый лак



Azalia Ceramic 90 75 N

blat: ceramika, efekt marmuru | top: ceramics, marble effect | столешница: керамика, эффект мрамора
stelaż: metal, złoty | frame: metal, golden | каркас: металл, золотой

Azalia 80 75

blat: szkło hartowane | top: tempered glass | столешница: каленое стекло
stelaż: metal, złoty | frame: metal, golden | каркас: металл, золотой



czarny 19 | black 19



beż 28 | beige 28

Bono Velvet 77 44 53 47 N

tkanina aksamit: Bluvel | velvet fabric: Bluvel | ткань бархат: Bluvel
metal, złoty | metal, golden | металл, золотой



Azalia Ceramic 50 60 N

blat: ceramika, efekt marmuru | top: ceramics, marble effect | столешница: керамика, эффект мрамора
stelaż: metal, złoty | frame: metal, golden | каркас: металл, золотой



Ceres



Ceres 80 140 75

blat: MDF+szkło, efekt marmuru | top: MDF+glass, marble effect | столешница: МДФ+стекло, эффект мрамора
stelaż: metal, złoty | frame: metal, golden | каркас: металл, золотой



biały | white | белый



Espero 90 75

blat: ceramika Calacatta | top: ceramics Calacatta | столешница: керамика Calacatta
stelaż: metal, biały / złoty | frame: metal, color: white / golden | каркас: металл, цвет: белый / золотой

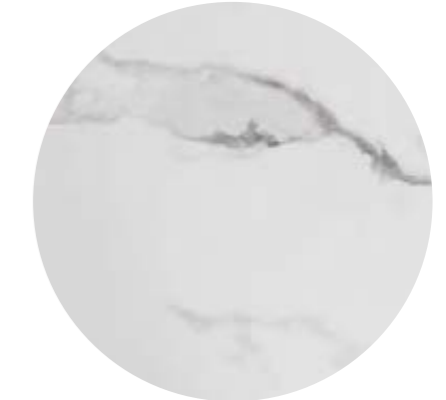

Calacatta
biały połysk | white high gloss | белый лак



Agis



Calvin 100 75

blat: szkło hartowane, efekt marmuru | top: tempered glass, marble effect | столешница: каленое стекло, эффект мрамора
stelaż: metal, złoty | frame: metal, golden | каркас: металл, золотой



czarny | black | черный



Agis 90 72

blat: szkło hartowane | top: tempered glass | столешница: каленое стекло
stelaż: metal, złoty | frame: metal, golden | каркас: металл, золотой



Agis A 60 45 N

ława, blat: szkło hartowane | coffee table, top: tempered glass | столик, столешница: каленое стекло
stelaż: metal, złoty | frame: metal, golden | каркас: металл, золотой



Porto Ceramic



Porto Ceramic



blat: szkło hartowane+hiszpańska ceramika Corso Grey | top: tempered glass+spanish ceramics Corso Grey | столешница: каленое стекло+испанская керамика Corso Grey
 stelaż: metal, czarny mat | frame: metal, black mat | каркас: металл, черный матовый

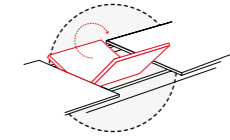

Corso Grey
 ciemny szary mat | dark grey mat | темный серый матовый



Porto Ceramic

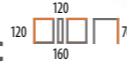

blat: szkło hartowane+hiszpańska ceramika Corso Grey | top: tempered glass+spanish ceramics Corso Grey | столешница: каленое стекло+испанская керамика Corso Grey
 stelaż: szczerkowana stal nierdzewna | frame: brushed stainless steel | каркас: нержавеющая сталь

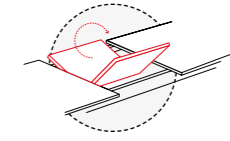

Corso Grey
 ciemny szary mat | dark grey mat | темный серый матовый



Murano



NOWY WYMIAR

Murano $\phi 90$ $\square 76$ $\phi 120$ $\square 76$

blat: ceramika, efekt marmuru | top: ceramics, marble effect | столешница: керамика, эффект мрамора
 stelaż: metal, chrom | frame: metal, chrome | каркас: металл, хром



biały połysk | white high gloss | белый лак



NOWY WYMIAR

Murano $\phi 90$ $\square 76$ $\phi 120$ $\square 76$

blat: ceramika, efekt marmuru | top: ceramics, marble effect | столешница: керамика, эффект мрамора
 stelaż: metal, czarny mat | frame: metal, black mat | каркас: металл, черный матовый



szary mat | grey mat | серый матовый



Angel $\phi 120$ $\square 75$

blat: laminowany MDF, efekt marmuru | top: laminated MDF, marble effect | stołeshnica: laminowane MDF, efekt marmora
stelaż: MDF, czarny mat | frame: MDF, black mat | каркас: МДФ, черный матовый



szary mat | grey mat | серый матовый



Angel $\phi 120$ $\square 75$

blat: MDF+okleina naturalna | top: MDF+natural veneer | stołeshnica: МДФ+натуральный шпон
stelaż: MDF+lakierowana okleina naturalna, czarny | frame: MDF+high gloss natural veneer, black | каркас: МДФ+лакированный натуральный шпон, черный



orzech | walnut | орех



Angel $\phi 120$ $\square 75$

blat: MDF+okleina naturalna | top: MDF+natural veneer | stołeshnica: МДФ+натуральный шпон
stelaż: MDF+okleina naturalna, dąb | frame: MDF+natural veneer, oak | каркас: МДФ+натуральный шпон, дуб



dąb | oak | дуб

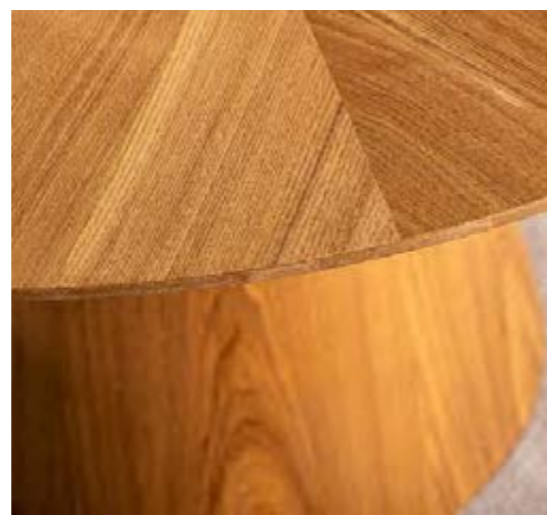

Angel



Angel



biały połysk
white high gloss
белый лак

Socrates $\phi 120 \square 75$ N

blat: ceramika | top: ceramics | столешница: керамика
stelaż: MDF+okleina, dąb artisan | frame: MDF+veneer, dąb artisan | каркас: МДФ+шпон, дуб артисан



Socrates



dąb artisan | artisan oak | дуб артисан

Socrates $\phi 100 \square 75$ N

stelaż: MDF+okleina | frame: MDF+veneer | каркас: МДФ+шпон
stelaż: MDF+okleina, dąb artisan | frame: MDF+veneer, dąb artisan | каркас: МДФ+шпон, дуб артисан



Socrates





Domingo I



Domingo

blat: okleina naturalna | top: natural veneer | столешница: нат. шпон
 stelaż: metal, czarny mat | frame: metal, black mat | каркас: металл, черный матовый



czarny mat | black mat | черный матовый



Domingo

blat: okleina naturalna | top: natural veneer | столешница: нат. шпон
 stelaż: metal, czarny mat | frame: metal, black mat | каркас: металл, черный матовый



dąb | oak | дуб



Galaxy



Domingo II

blat: okleina naturalna | top: natural veneer | столешница: нат. шпон
 stelaż: metal, czarny mat | frame: metal, black mat | каркас: металл, черный матовый



dąb | oak | дуб



Galaxy

blat: płyta laminowana | top: laminated board | столешница: ламин. ДСП
 stelaż: metal, czarny mat | frame: metal, black mat | каркас: металл, черный матовый



dąb artisan | artisan oak | дуб артисан



Gaston

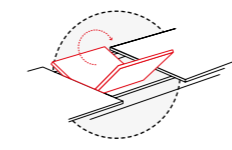

Gaston



NOWY KOLOR

blat: MDF+okleina, efekt marmuru | top: MDF+veneer, marble effect | столешница: МДФ+шпон, эффект мрамора
 stelaż: metal, czarny mat | frame: metal, black mat | каркас: металл, черный матовый



biały | white | белый

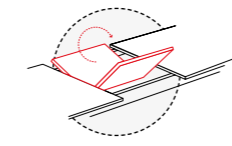

Gaston



NOWY KOLOR

blat: MDF+okleina, efekt marmuru | top: MDF+veneer, marble effect | столешница: МДФ+шпон, эффект мрамора
 stelaż: metal, czarny mat | frame: metal, black mat | каркас: металл, черный матовый



czarny | black | черный



Gaston

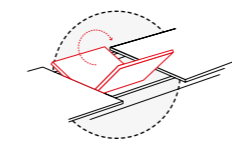

Gaston



NOWY KOLOR

blat: MDF+okleina | top: MDF+veneer | столешница: МДФ+шпон
 stelaż: metal, czarny mat | frame: metal, black mat | каркас: металл, черный матовый



orzech vintage | vintage walnut | винтажный орех

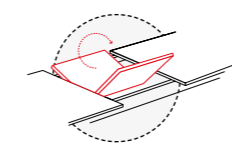

Gaston



NOWY KOLOR

blat: MDF+okleina | top: MDF+veneer | столешница: МДФ+шпон
 stelaż: metal, czarny mat | frame: metal, black mat | каркас: металл, черный матовый



dąb artisan | artisan oak | дуб артисан



Talia



biały połysk | white high gloss | белый лак



szary połysk | grey high gloss | серый лак

Talia $\phi 120 \square 73$

blat: ceramika, efekt marmuru | top: ceramics, marble effect | столешница: керамика, эффект мрамора
 stelaż: metal, czarny mat | frame: metal, black mat | каркас: металл, черный матовый



biały mat | white mat | белый матовый



szary mat | grey mat | серый матовый

Talia $\phi 90 \square 75$

blat: ceramika, efekt marmuru | top: ceramics, marble effect | столешница: керамика, эффект мрамора
 stelaż: metal, czarny mat | frame: metal, black mat | каркас: металл, черный матовый



Talia II



orzech | walnut | орех



dąb | oak | дуб

Talia II $\phi 90 \square 76$

blat: MDF+melamina | top: MDF+melamine finish | столешница: МДФ+меламин
 stelaż: metal, czarny mat | frame: metal, black mat | каркас: металл, черный матовый



Aster



Aster $\phi 120$ $\square 76$

blat: MDF+okleina | top: MDF+veneer | stołешница: МДФ+шпон
 stelaż: metal, czarny mat | frame: metal, black mat | каркас: металл, черный матовый



biały, efekt marmuru
 white, marble effect
 белый, эффект мрамора

NOWY KOLOR



orzech vintage | vintage walnut | винтажный орех

NOWY KOLOR



dąb | oak | дуб



Aster $\phi 100$ $\square 76$ NOWY WYMIAR

blat: MDF+okleina | top: MDF+veneer | стоłешница: МДФ+шпон
 stelaż: metal, czarny mat | frame: metal, black mat | каркас: металл, черный матовый



biały, efekt marmuru
 white, marble effect
 белый, эффект мрамора

NOWY KOLOR



orzech vintage | vintage walnut | винтажный орех

NOWY KOLOR

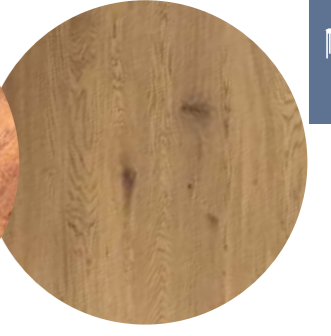

dąb | oak | дуб

NOWY KOLOR



Tetis



Tetis $\phi 100$ $\square 76$

blat: MDF+okleina | top: MDF+veneer | стоłешница: МДФ+шпон
 stelaż: metal, czarny mat | frame: metal, black mat | каркас: металл, черный матовый



biały, efekt marmuru
 white, marble effect
 белый, эффект мрамора

NOWY KOLOR



orzech vintage | vintage walnut | винтажный орех

NOWY KOLOR



dąb | oak | дуб



Colt $\phi 90$ $\square 76$ NOWY WYMIAR

blat: MDF+okleina | top: MDF+veneer | стоłешница: МДФ+шпон
 stelaż: metal, czarny mat | frame: metal, black mat | каркас: металл, черный матовый



dąb | oak | дуб



Colt $\phi 90$ $\square 76$ N

blat: szkło hartowane transparentne | top: transparent tempered glass | стоłешница: закаленное стекло
 stelaż: metal, czarny mat | frame: metal, black mat | каркас: металл, черный матовый



Alto II



Alto $\phi 120$ $\square 76$

blat: płyta laminowana | top: laminated board | столешница: ламин. ДСП
stelaż: metal, czarny mat | frame: metal, black mat | каркас: металл, черный матовый



dąb | oak | дуб



Alto II $\phi 80$ $\square 76$ **NOWY WYMIAR**

blat: płyta laminowana | top: laminated board | столешница: ламин. ДСП
stelaż: metal, czarny mat | frame: metal, black mat | каркас: металл, черный матовый



biały, efekt marmuru
white, marble effect
белый, эффект мрамора
NOWY KOLOR



brąz rustykalny | rustic brown | рустикальный коричневый
NOWY KOLOR

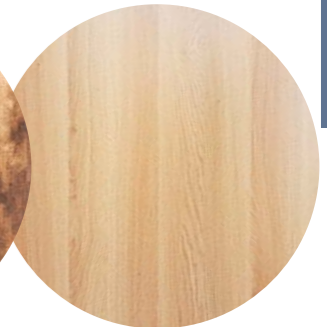

dąb | oak | дуб



Luna



Luna $\phi 90$ $\square 76$

blat: płyta laminowana | top: laminated board | столешница: ламин. ДСП
stelaż: metal, czarny mat | frame: metal, black mat | каркас: металл, черный матовый



biały, efekt marmuru
white, marble effect
белый, эффект мрамора
NOWY KOLOR



brąz rustykalny | rustic brown | рустикальный коричневый
NOWY KOLOR



dąb | oak | дуб



Oakland $\phi 100$ $\square 75$

blat: MDF+okleina | top: MDF+veneer | столешница: МДФ+шпон
stelaż: metal, czarny mat | frame: metal, black mat | каркас: металл, черный матовый



orzech | walnut | орех



Rolf



plyta laminowana
laminated board
ламинированное ДСП



lite drewno dębowe
solid oak wood
массив дуба

Rolf dąb / Rolf laminat 490 78

blat: lite drewno dębowe / plyta laminowana | top: solid oak wood / laminated board | массив дуба / ламинированное ДСП
stół: массив дуба / ламинированное ДСП | stelaż: metal, czarny mat | frame: metal, black mat | каркас: металл, черный матовый



plyta laminowana
laminated board
ламинированное ДСП



lite drewno dębowe
solid oak wood
массив дуба

Cono dąb / Cono laminat 490 78

blat: lite drewno dębowe / plyta laminowana | top: solid oak wood / laminated board | массив дуба / ламинированное ДСП
stół: массив дуба / ламинированное ДСП | stelaż: metal, czarny mat | frame: metal, black mat | каркас: металл, черный матовый



Ritmo



dąb | oak | дуб

Ritmo 420 75

blat: MDF-okleina | top: MDF-veneer | столешница: МФФ-шпон
stelaż: metal, czarny mat | frame: metal, black mat | каркас: металл, черный матовый



biały mat | white mat | белый мат

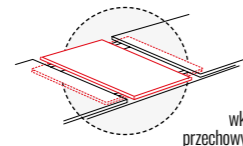

wkładka przechowywana osobno

Opera

102 102 73 144

blat: płyta laminowana | top: laminated board | столешница: ламинированное ДСП
stelaż: drewno, buk | frame: wood, beech | каркас: древесина, бук



biały | white | белый



biały | white | белый

Larson

φ90 75

blat: MDF | top: MDF | столешница: МДФ
stelaż: drewno, biały | frame: wood, white | каркас: древесина, белый

Larson

φ90 75

blat: MDF | top: MDF | столешница: МДФ
stelaż: drewno, dąb bielony | frame: wood, white wash oak | каркас: древесина, беленый дуб



dąb miodowy | honey oak | медовый дуб



dąb | oak | дуб

Nelson

φ90 75

blat: MDF+okleina naturalna | top: MDF+natural veneer | столешница: МДФ+нат. шпон
stelaż: drewno, dąb miodowy | frame: wood, honey oak | каркас: древесина, медовый дуб

Karl

80 90 75

blat: MDF+okleina naturalna | top: MDF+natural veneer | столешница: МДФ+нат. шпон
stelaż: drewno, dąb | frame: wood, oak | каркас: древесина, дуб



dąb | oak | дуб



biały | white | белый

Mosso II

φ90 75

blat: MDF+okleina naturalna | top: MDF+natural veneer | столешница: МДФ+нат. шпон
stelaż: drewno, dąb | frame: wood, oak | каркас: древесина, дуб

Mosso II

φ100 75

blat: MDF | top: MDF | столешница: МДФ
stelaż: drewno, dąb | frame: wood, oak | каркас: древесина, дуб



Opera



Nelson



Agis



Agis $\phi 90$ $\square 75$

blat: MDF+okleina | top: MDF+veneer | столешница: МДФ+шпон
stelaż: metal, czarny mat | frame: metal, black mat | каркас: металл, черный матовый



orzech | walnut | орех



Agis $\phi 90$ $\square 71$

blat: ceramika | top: ceramics | столешница: керамика
stelaż: metal, chrom | frame: metal, chrome | каркас: металл, хром

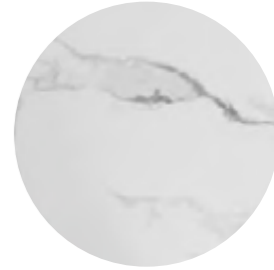

biały połysk | white high gloss | белый лак



Agis $\phi 90$ $\square 72$

blat: szkło hartowane | top: tempered glass | столешница: каленое стекло
stelaż: metal, złoty / chrom / czarny mat | frame: metal, golden / chrome / black mat | каркас: металл, золотой / хром / черный матовый

złoty | golden | золотой

chrom | chrome | хром



czarny matowy | black mat | черный матовый

NOWY KOLOR



Ideal



Cyryl II $\phi 100$ $\square 76$

blat: MDF+szkło hartowane, efekt kamienia | top: MDF+tempered glass, stone effect | столешница: МДФ+каленое стекло, эффект мрамора
stelaż: metal, czarny mat+złoty | frame: metal, black mat+golden | каркас: металл, черный матовый+золотой



szary | grey | серый



Ideal $\phi 100$ $\square 76$

blat: MDF+szkło, efekt marmuru | top: MDF+glass, marble effect | столешница: МДФ+стекло, эффект мрамора
stelaż: metal, czarny mat | frame: metal, black mat | каркас: металл, черный матовый

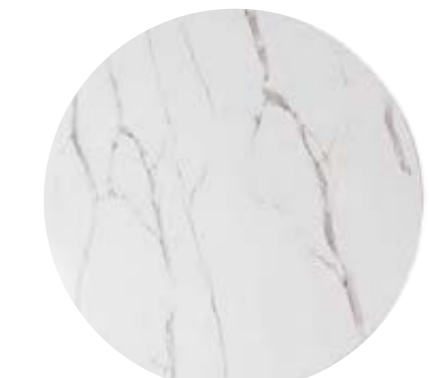

biały | white | белый



Espero

Espero $\phi 90$ $\square 75$

blat: ceramika Calacatta | top: Calacatta ceramics | столешница: керамика Calacatta
 stelaż: metal, biały / złoty | frame: metal, color: white / golden | каркас: металл, цвет: белый / золотой



Calacatta
 biały połysk | white high gloss | белый лак

Espero $\phi 80$ $\square 75$

blat: ceramika | top: ceramics | столешница: керамика
 stelaż: metal, czarny mat | frame: metal, black mat | каркас: металл, черный матовый

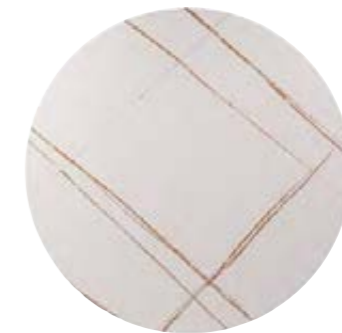

biały mat | white mat | белый мат



czarny mat | black mat | черный мат



Amadeo

Espero II $\phi 80$ $\square 75$

blat: ceramika | top: ceramics | столешница: керамика
 stelaż: metal, czarny mat | frame: metal, black mat | каркас: металл, черный матовый



czarny mat | black mat | черный мат



orzech | walnut | орех

Amadeo $\phi 80$ $\square 76$ $\phi 100$ $\square 76$

blat: MDF+okleina naturalna orzechowa | top: MDF+natural walnut veneer | столешница: МДФ+нат. шпон
 stelaż: metal, czarny mat | frame: metal, black mat | каркас: металл, черный матовый

Amadeo II $\phi 90$ $\square 76$

blat: MDF+melamina | top: MDF+melamine finish | столешница: МДФ+меламин
 stelaż: metal, czarny mat | frame: metal, black mat | каркас: металл, черный матовый



orzech | walnut | орех



dąb | oak | дуб



Kent



Kent 85 130 175 76

blat: płyta laminowana | top: laminated board | столешница: ламинированное ДСП
 stelaż: płyta laminowana | frame: laminated board | каркас: ламинированное ДСП



dąb artisan / czarny
 artisan oak / black
 дуб артисан / черный



Nevio 75 125 170 76

blat: płyta laminowana | top: laminated board | столешница: ламинированное ДСП
 stelaż: płyta laminowana | frame: laminated board | каркас: ламинированное ДСП

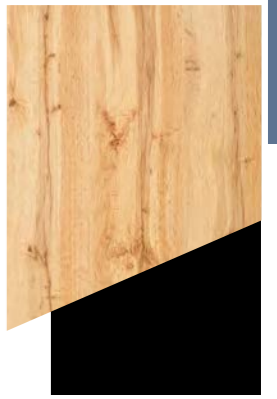

dąb artisan / czarny
 artisan oak / black
 дуб артисан / черный



Tampa



Vento 68 120 160 76

blat: płyta laminowana | top: laminated board | столешница: ламинированное ДСП
 stelaż: płyta laminowana | frame: laminated board | каркас: ламинированное ДСП



dąb artisan / czarny
 artisan oak / black
 дуб артисан / черный



Tampa 60 100 135 79

blat: płyta laminowana | top: laminated board | столешница: ламинированное ДСП
 stelaż: płyta laminowana | frame: laminated board | каркас: ламинированное ДСП

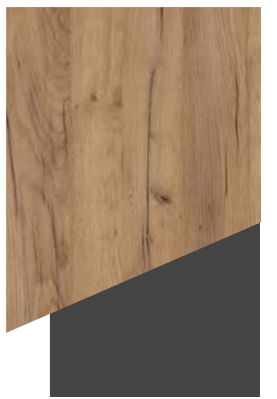

dąb złoty craft / antracyt
 golden craft / anthracite
 дуб золотой крафт / антрацит



Next



Nigel



Calipso

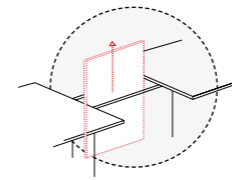

Next 68 110 153 75

blat: płyta laminowana | top: laminated board | столешница: ламинированное ДСП
 stelaż: płyta laminowana | frame: laminated board | каркас: ламинированное ДСП

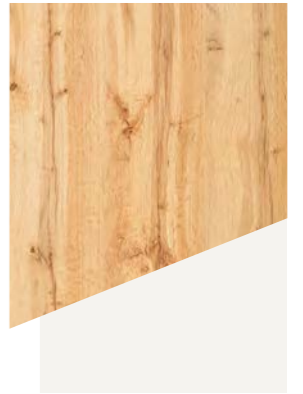

dąb artisan / biały mat
 artisan oak / white mat
 дуб артисан / белый мат

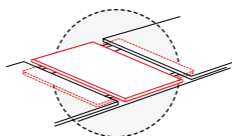

Nigel 80 120 160 76

blat: płyta laminowana | top: laminated board | столешница: ламинированное ДСП
 stelaż: płyta laminowana | frame: laminated board | каркас: ламинированное ДСП



dąb wotan / brąz wotan oak / brown
 дуб вотан / коричневый
 dąb artisan / biały mat
 artisan oak / white mat
 дуб артисан / белый мат

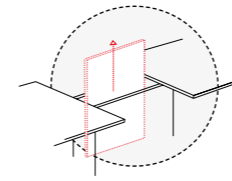

Calipso 68 110 145 76 NOWY KOLOR

blat: płyta laminowana | top: laminated board | столешница: ламинированное ДСП
 stelaż: płyta laminowana | frame: laminated board | каркас: ламинированное ДСП



old wood / materia, c. szary
 old wood / materia, d. grey
 old wood / materia, т. серый

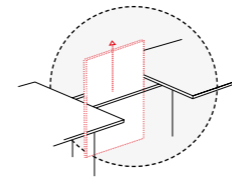

Calipso 68 110 145 76

blat: płyta laminowana | top: laminated board | столешница: ламинированное ДСП
 stelaż: płyta laminowana | frame: laminated board | каркас: ламинированное ДСП



biały mat / efekt betonu
 white mat / concrete effect
 белый мат / эффект бетона
 biały mat / dąb wotan
 white mat / wotan oak
 белый мат / дуб вотан



Syriusz

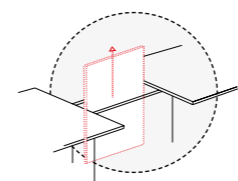

Syriusz

blat: płyta laminowana | top: laminated board | столешница: ламинированное ДСП
 stelaż: płyta laminowana | frame: laminated board | каркас: ламинированное ДСП



efekt betonu / biały mat
 concrete effect / white mat
 эффект бетона / белый мат

dąb wotan / biały mat
 wotan oak / white mat
 дуб вотан / белый мат



Vidar

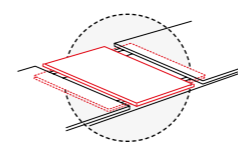

Vidar

blat: płyta laminowana | top: laminated board | столешница: ламинированное ДСП
 stelaż: płyta laminowana | frame: laminated board | каркас: ламинированное ДСП



dąb craft tobacco / krem
 craft tobacco oak / cream
 дуб крафт табако / кремовый



Exel

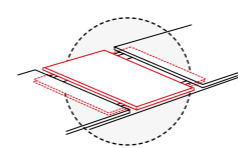

Exel

blat: płyta laminowana | top: laminated board | столешница: ламинированное ДСП
 stelaż: płyta laminowana | frame: laminated board | каркас: ламинированное ДСП



dąb wotan / srebrny
 wotan oak / silver
 дуб вотан / серебряный

dąb wotan / biały
 wotan oak / white
 дуб вотан / белый

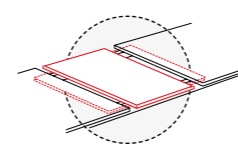

Exel

blat: płyta laminowana | top: laminated board | столешница: ламинированное ДСП
 stelaż: płyta laminowana | frame: laminated board | каркас: ламинированное ДСП



old wood / materia, c. szary
 old wood / materia, d. grey
 old wood / materia, т. серый

dąb artisan / antracyt
 artisan oak / anthracite
 дуб артисан / антрацит



Platon



Crocus



Huston

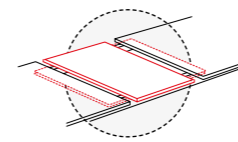

Platon 80 136 176 76

blat: płyta laminowana | top: laminated board | столешница: ламинированное ДСП
stelaż: płyta laminowana | frame: laminated board | каркас: ламинированное ДСП



dąb wotan / brąz wotan oak / brown dуб вотан / коричневый

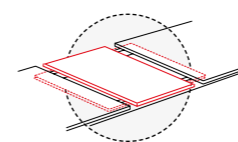

Platon 80 136 176 76 **NOWY KOLOR**

blat: płyta laminowana | top: laminated board | столешница: ламинированное ДСП
stelaż: płyta laminowana | frame: laminated board | каркас: ламинированное ДСП



old wood / materia, c. szary old wood / materia, d. grey old wood / materia, т. серый

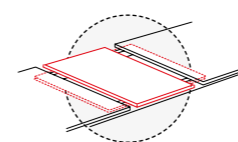

Crocus 80 120 160 76

blat: płyta laminowana | top: laminated board | столешница: ламинированное ДСП
stelaż: płyta laminowana | frame: laminated board | каркас: ламинированное ДСП

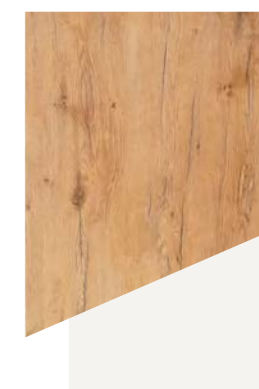

dąb wotan / biały mat wotan oak / white mat dуб вотан / белый мат

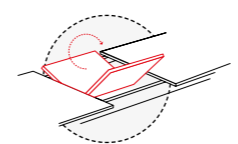

Huston 80 120 160 76

blat: MDF+okleina | top: MDF+veneer | столешница: МФД+шпон
stelaż: MDF+okleina+szkło hartowane, czarny lakier | frame: MDF+veneer+tempered glass, black high gloss | каркас: МФД+шпон+каленое стекло, черный лак



dąb / czarny lakier oak / black high gloss dуб / черный лак



Presto

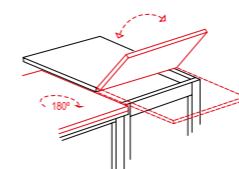

Flip



blat: płyta laminowana | top: laminated board | столешница: ламинированное ДСП
 stelaż: płyta laminowana, czarny mat | frame: laminated board, black mat | каркас: ламинированное ДСП, черный мат



dąb artisan / czarny mat
 artisan oak / black mat
 дуб артисан / черный мат

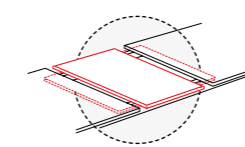

Presto



blat: płyta laminowana | top: laminated board | столешница: ламинированное ДСП
 stelaż: płyta laminowana, czarny mat | frame: laminated board, black mat | каркас: ламинированное ДСП, черный мат



dąb artisan / czarny mat
 artisan oak / black mat
 дуб артисан / черный мат



Dante

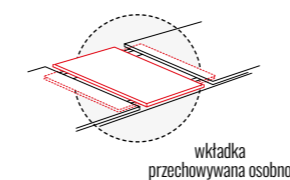

Dante



blat: płyta laminowana | top: laminated board | столешница: ламинированное ДСП
 stelaż: płyta laminowana, czarny mat | frame: laminated board, black mat | каркас: ламинированное ДСП, черный мат



dąb artisan / czarny mat
 artisan oak / black mat
 дуб артисан / черный мат

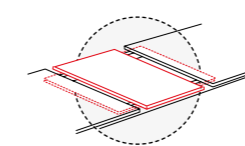

Horacy



blat: płyta laminowana | top: laminated board | столешница: ламинированное ДСП
 stelaż: płyta laminowana, czarny mat | frame: laminated board, black mat | каркас: ламинированное ДСП, черный мат



dąb artisan / czarny mat
 artisan oak / black mat
 дуб артисан / черный мат



Diego II



Fiesta



dąb | oak | дуб

Mosso III 80 80 75

blat: MDF+okleina naturalna | top: MDF+natural veneer | столешница: МДФ+нат. шпон
stelaż: drewno, dąb | frame: wood, oak | каркас: древесина, дуб



biały | white | белый

Mosso I 75 120 75

blat: MDF | top: MDF | столешница: МДФ
stelaż: drewno, dąb | frame: wood, oak | каркас: древесина, дуб



biały | white | белый

Fiord 70 110 74 60 80 74

blat: MDF | top: MDF | столешница: МДФ
stelaż: drewno, biały | frame: wood, white | каркас: древесина, белый



biały | white | белый

Tibi 80 90 75

blat: MDF | top: MDF | столешница: МДФ
stelaż: drewno, dąb bielony | frame: wood, white wash oak | каркас: древесина, беленый дуб



dąb artisan | artisan oak | дуб артисан

Diego II 65 105 140 75 68 120 160 75

blat: płyta laminowana | top: laminated board | столешница: ламинированное ДСП
stelaż: MDF, czarny, dąb sonoma | frame: MDF, black, sonoma oak | каркас: МДФ, черный, дуб сонома

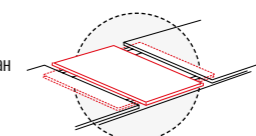

dąb sonoma | sonoma oak | дуб сонома



Fiesta 67 67 78 N

blat: płyta laminowana | top: laminated board | столешница: ламин. ДСП
stelaż: płyta laminowana, biały, dąb artisan | frame: laminated board, white, artisan oak | каркас: ламин. ДСП, белый, дуб артисан



dąb artisan
artisan oak
дуб артисан



biały efekt marmuru
white marble effect
белый эффект мрамора



dąb | oak | дуб



Adam 60 ¹⁰⁰ ⁷⁵

blat: płyta laminowana | top: laminated board | столешница: ламинированное ДСП
stelaż: MDF, biały mat | frame: MDF, white mat | каркас: МДФ, белый матовый



Adam 60 ¹⁰⁰ ⁷⁵

blat: płyta laminowana | top: laminated board | столешница: ламинированное ДСП
stelaż: MDF, biały mat | frame: MDF, white mat | каркас: МДФ, белый матовый



dąb artisan | artisan oak | дуб артисан



Adam 65 ⁹⁰ ⁷⁵ 60 ¹⁰⁰ ⁷⁵ 68 ¹²⁰ ⁷⁵

blat: płyta laminowana | top: laminated board | столешница: ламинированное ДСП
stelaż: MDF, czarny | frame: MDF, black | каркас: МДФ, черный



Adam 65 ⁹⁰ ⁷⁵



dąb lancetol | lancetol oak | дуб ланселот



Adam 60 ¹⁰⁰ ⁷⁵ 68 ¹²⁰ ⁷⁵

blat: płyta laminowana | top: laminated board | столешница: ламинированное ДСП
stelaż: MDF, antracyt | frame: MDF, anthracite | каркас: МДФ, антрацит



Adam 60 ¹⁰⁰ ⁷⁵ 68 ¹²⁰ ⁷⁵

blat: płyta laminowana | top: laminated board | столешница: ламинированное ДСП
stelaż: MDF, biały mat | frame: MDF, white mat | каркас: МДФ, белый матовый



złoty craft | golden craft | золотой крафт



Adam 60 ¹⁰⁰ ⁷⁵

blat: płyta laminowana | top: laminated board | столешница: ламинированное ДСП
stelaż: MDF, biały mat | frame: MDF, white mat | каркас: МДФ, белый матовый



Fiesta



dąb sonoma | sonoma oak | дуб сонома



Adam 60 ¹⁰⁰ ⁷⁵

blat: płyta laminowana | top: laminated board | столешница: ламинированное ДСП
stelaż: MDF, biały mat | frame: MDF, white mat | каркас: МДФ, белый матовый



Adam 65 ⁹⁰ ⁷⁵

blat: płyta laminowana | top: laminated board | столешница: ламинированное ДСП
stelaż: MDF, dąb sonoma | frame: MDF, sonoma oak | каркас: МДФ, дуб сонома



dąb wotan | wotan oak | дуб вотан



Adam 60 ¹⁰⁰ ⁷⁵

blat: płyta laminowana | top: laminated board | столешница: ламинированное ДСП
stelaż: MDF, biały mat | frame: MDF, white mat | каркас: МДФ, белый матовый



GD-017



GD-017

blat: MDF+okleina | top: MDF+veneer | столешница: МДФ+шпон
 stelaż: metal, czarny mat | frame: metal, black mat | каркас: металл, черный матовый

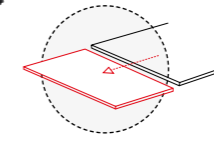
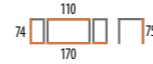

orzech vintage
 vintage walnut
 винтажный орех

dąb artisan
 artisan oak
 дуб артисан

NOWY KOLOR



GD-017

blat: MDF+okleina | top: MDF+veneer | столешница: МДФ+шпон
 stelaż: metal, czarny mat | frame: metal, black mat | каркас: металл, черный матовый

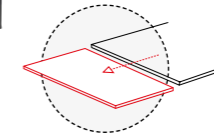
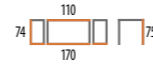

biały, efekt marmuru
 white, marble effect
 белый, эффект мрамора

NOWY KOLOR



GD-082



GD-082

blat: MDF+okleina | top: MDF+veneer | столешница: МДФ+шпон
 stelaż: metal, czarny mat | frame: metal, black mat | каркас: металл, черный матовый

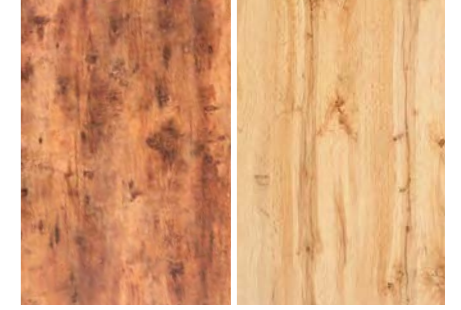
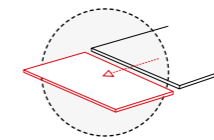
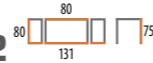

orzech vintage
 vintage walnut
 винтажный орех

dąb artisan
 artisan oak
 дуб артисан

NOWY KOLOR



GD-082

blat: MDF+okleina | top: MDF+veneer | столешница: МДФ+шпон
 metal, czarny mat | metal, black mat | металл, черный матовый

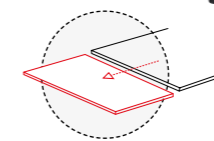
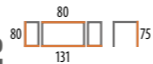

biały, efekt marmuru
 white, marble effect
 белый, эффект мрамора

NOWY KOLOR

80 100 110
60 75 60 75 70 75



dąb artisan
artisan oak
дуб артисан

80 100 110
60 75 60 75 70 75

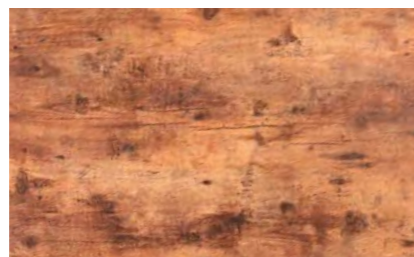

orzech vintage
vintage walnut
винтажный орех

80 100 110
60 75 60 75 70 75



biały, efekt marmuru
white, marble effect
белый, эффект мрамора



Damar NOWY KOLOR

blat: MDF+okleina | top: MDF+veneer | столешница: МДФ+шпон
stelaż: metal, szary mat | frame: metal, black mat | каркас: металл, черный матовый



Damar



kreem / cream / кремовый



szary / grey / серый



szary / black / черный



biały / white / белый

Damar 80 100
60 75 60 75

blat: szkło hartowane | top: tempered glass | столешница: каленое стекло
stelaż: metal malowany | frame: painted metal | каркас: крашенный металл



Damar



GD-017



GD-017

blat: szkło hartowane | top: tempered glass | столешница: каленое стекло
 stelaż: metal, chrom | frame: metal, chrome | каркас: металл, хром

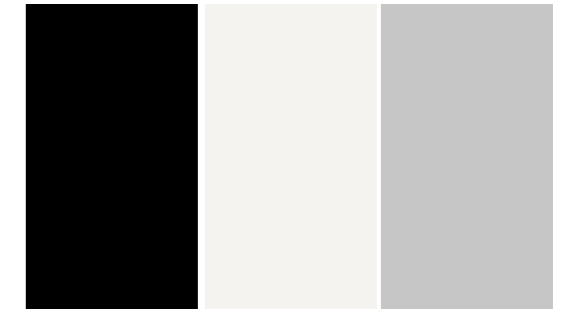
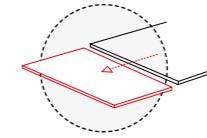
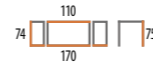

czarny
black
черный

biały
white
белый

szary
grey
серый



GD-020

blat: szkło hartowane | top: tempered glass | столешница: каленое стекло
 stelaż: metal, chrom | frame: metal, chrome | каркас: металл, хром

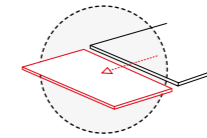

biały | white | белый



GD-020



60 100 75 70 110 75
 krem / cream / кремовый



60 100 75 70 110 75
 biały / white / белый



60 100 75
 czarny / black / черный



60 100 75
 szary / grey / серый

Galant

blat: szkło hartowane | top: tempered glass | столешница: каленое стекло
 stelaż: metal, metal malowany | frame: painted metal | каркас: крашенный металл



Pub H $\phi 60$ $\square 105$ **N**

blat: metal | top: metal | stołешница: металл
stelaż: metal, czarny mat | frame: metal, black mat | каркас: металл, черный матовый



Pub $\phi 60$ $\square 73$ **N**

blat: metal | top: metal | stołешница: металл
stelaż: metal, czarny mat | frame: metal, black mat | каркас: металл, черный матовый



Pub K $\phi 60$ $\square 73$ **N**

blat: metal | top: metal | stołешница: металл
stelaż: metal, czarny mat | frame: metal, black mat | каркас: металл, черный матовый



BT-001 $\phi 60$ $\square 76$ **N**

blat: MDF matowy | top: mat MDF | стол: матовый МДФ
stelaż: metal, czarny mat | frame: metal, black mat | каркас: металл, черный матовый



BT-002 $\phi 60$ $\square 76$ **N**

blat: MDF matowy | top: mat MDF | стол: матовый МДФ
stelaż: metal, biały mat | frame: metal, white mat | каркас: металл, белый матовый



BT-007 $\phi 60$ $\square 105$ **N**

blat: ceramika, czarny mat | top: ceramics, black mat | стол: керамика, черный матовый
stelaż: metal, czarny mat | frame: metal, black mat | каркас: металл, черный матовый



dąb artisan
artisan oak
дуб артисан

BT-005 $\phi 60$ $\square 105$ **N**

blat: MDF+okleina | top: MDF+veneer | stołешница: МДФ+шпон
stelaż: metal, czarny mat | frame: metal, black mat | каркас: металл, черный матовый



dąb artisan
artisan oak
дуб артисан

BT-006 $\phi 60$ $\square 105$ **N**

blat: MDF+okleina | top: MDF+veneer | stołешница: МДФ+шпон
stelaż: metal, czarny mat | frame: metal, black mat | каркас: металл, черный матовый

Puro | Puro II

Puro

Puro | Puro II

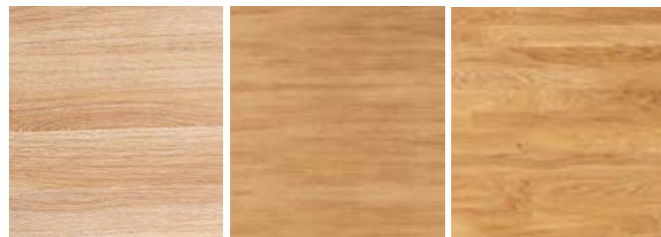

plyta laminowana
laminated board
ламинированное ДСП

okleina naturalna
natural veneer
нат. шпон

lite drewno dębowe
solid oak wood
массив дуба



Puro dąb / laminat / okleina naturalna

blat: wg wzornika | top: color swatch | стол: шаблон
stelaż: metal, czarny mat | frame: metal, black mat | каркас: металл, черный матовый

Puro II $\phi 60$ $\square 73$ $\phi 70$ $\square 73$ $\phi 80$ $\square 73$ **Puro** $\phi 60$ $\square 76$ $\phi 70$ $\square 76$ $\phi 80$ $\square 76$



Pub K



Puro II



Puro



Olivia



Dello



Olivia



Margo



Olivia



esru | эскрю



biały | white | белый



c. orzech | d. walnut | т. орех



Olivia

blat: MDF | top: MDF | столешница: МДФ
stelaż: drewno | frame: wood | каркас: древесина

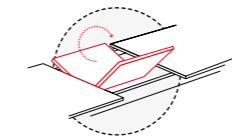
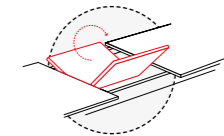

Margo

blat: MDF+okleina naturalna | top: natural veneer | столешница: МДФ+нат. шпон
stelaż: drewno | frame: wood | каркас: древесина



c. orzech | d. walnut | т. орех



biały | white | белый

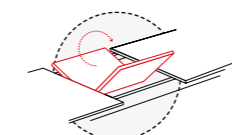

Dello

blat: MDF | top: MDF | столешница: МДФ
stelaż: drewno | frame: wood | каркас: древесина





Libra



Virgo $\phi 50$ $\square 57$

blat: ceramika, stelaż: metal, kolor: biały połysk, efekt marmuru / czarny mat+złoty szczotkowany
top: ceramics, frame: metal, color: white high gloss, marble effect / black mat+golden brushed
стол: керамика, каркас: металл, цвет: белый лак, э. мрамора / черный мат+золотой матовый



Libra $\phi 51$ $\square 61$

blat: metal, stelaż: metal, kolor: czarny mat / czarny mat+złoty szczotkowany
top: metal, frame: metal, color: black mat / black mat+brushed gold
стол: металл, каркас: металл, цвет: черный матовый / черный+золотой матовый



Hill $\phi 50$ $\square 46$ N

blat: ceramika, stelaż: metal, kolor: biały połysk, efekt marmuru / czarny mat
top: ceramics, frame: metal, color: white high gloss, marble effect / black mat
стол: керамика, каркас: металл, цвет: белый лак, эф. мрамора / черный матовый



Aries $\phi 50$ $\square 53$

blat: ceramika, stelaż: metal, kolor: biały połysk, efekt marmuru / złoty szczotkowany
top: ceramics, frame: metal, color: white high gloss, marble effect / brushed gold
стол: керамика, каркас: металл, цвет: белый лак, эффект мрамора / золотой



Seti $\phi 50$ $\square 53$ N

blat: szkło hartowane, kolor: czarny, stelaż: metal, kolor: złoty szczotkowany
top: tempered glass, color: black, frame: metal, color: brushed golden
стол: каленое стекло, цвет: черный, каркас: металл, цвет: золотой



Leo $\phi 50$ $\square 54$ N

blat: ceramika, stelaż: metal, kolor: biały połysk, efekt marmuru / szary+złoty
top: ceramics, frame: metal, color: white high gloss, marble effect / grey+gold
стол: керамика, каркас: металл, цвет: белый лак, эф. мрамора / серый+золотой



Gemini $\phi 50$ $\square 56$

blat: ceramika, stelaż: metal, kolor: biały połysk, efekt marmuru / czarny mat+złoty szczotkowany
top: ceramics, frame: metal, color: white high gloss, marble effect / black mat+brushed gold
стол: керамика, каркас: металл, цвет: белый лак, э. мрамора / черный мат+золотой



Taurus $\phi 40$ $\square 54$ N

blat: szkło hartowane dymione, kolor: czarny, stelaż: metal, kolor: czarny+złoty
top: smoked tempered glass, color: black, frame: metal, color: black+gold
стол: дымчатое кал. стекло, цвет: черный, каркас: металл, цвет: черный+золотой



Cyprus A $\phi 73$ $\square 37$ N

blat: ceramika, stelaż: metal, kolor: biały połysk, efekt marmuru / czarny mat+złoty szczotkowany | top: ceramics, frame: metal, color: white high gloss, marble effect / black mat+brushed gold
стол: керамика, каркас: металл, цвет: белый лак, э. мрамора / черный мат+золотой матовый



Cyprus B $\phi 48$ $\square 45$ N



Napa A $\phi 70$ $\square 43$ N

blat: ceramika, stelaż: metal, kolor: biały połysk, efekt marmuru / brąz+złoty | top: ceramics, frame: metal, color: white high gloss, marble effect / bronze+gold
стол: керамика, каркас: металл, цвет: белый лак, эффект мрамора / коричневый+золотой



Napa B $\phi 50$ $\square 53$ N



Aries



Leo



Tiffany

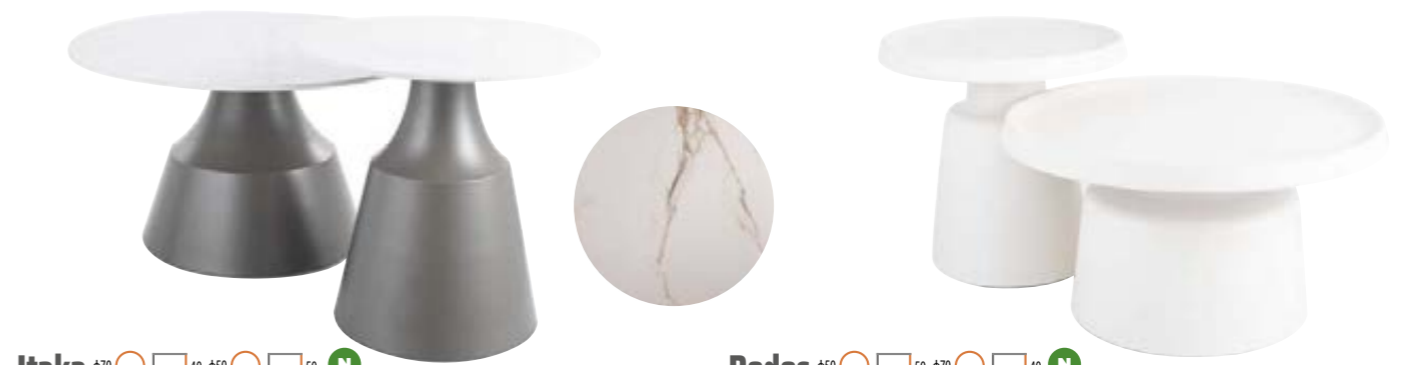

Itaka $\phi 70$ $\square 40$ $\phi 50$ $\square 50$ **N**

blat: ceramika, stelaż: metal, kolor: biały połysk / szary mat
top: ceramics, frame: metal, color: white high gloss / grey mat
stół: ceramika, каркас: металл, цвет: белый лак / серый матовый

Rodos $\phi 50$ $\square 50$ $\phi 70$ $\square 40$ **N**

blat: metal, stelaż: metal, kolor: jasny szary mat
top: metal, frame: metal, color: light grey mat
stół: металл, каркас: металл, цвет: светлый серый матовый



Mona $\phi 50$ $\square 46$ **N**

blat: tworzywo PP, stelaż: tworzywo PP, kolory: biały, szary, zielony | top: plastic, frame: plastic, colors: white, gray, green | stół: пластик, каркас: пластик, цвет: белый, серый, зеленый



Tiffany A Gold $\phi 50$ $\square 52$ **N**

blat: metal, złoty, stelaż: szkło, kolor: czarny, fioletowy, zielony
top: metal, golden, frame: glass, color: black, violet, green
stół: металл, золотой, каркас: стекло, цвет: черный, фиолетовый, зеленый

Tiffany A Black $\phi 50$ $\square 52$ **N**

blat: metal, czarny, stelaż: szkło, kolor: czarny, pomarańczowy, zielony
top: metal, black, frame: glass, color: black, orange, green
stół: металл, черный, каркас: стекло, цвет: черный, оранжевый, зеленый



Tiffany B Gold $\phi 70$ $\square 43$ **N**

blat: metal złoty, stelaż: szkło, kolor: czarny, fioletowy, zielony
top: metal, golden, frame: glass, color: black, violet, green
stół: металл, золотой, каркас: стекло, цвет: черный, фиолетовый, зеленый

Tiffany B Black $\phi 70$ $\square 43$ **N**

blat: metal, czarny, stelaż: szkło, kolor: czarny, pomarańczowy, zielony
top: metal, black, frame: glass, color: black, orange, green
stół: металл, черный, каркас: стекло, цвет: черный, оранжевый, зеленый



Mona



Ariana B



Vienna $\phi 60$ $\square 40$ $\phi 80$ $\square 45$

blat: szkło hartowane dymione, stelaż: stal nierdzewna, kolor: złoty, srebrny | top: smoked tempered glass, frame: stainless steel, color: golden, silver | стол: дымчатое каленое стекло, каркас: нерж. сталь, цвет: золотой, серебряный



Ottavia

Ottavia A $\phi 80$ $\square 43$

Ottavia B $\phi 50$ $\square 54$

blat: szkło hartowane burszynowe, stelaż: stal nierdzewna, kolor: złoty | top: amber tempered glass, frame: stainless steel, color: golden | стол: янтарное каленое стекло, каркас: нерж. сталь, цвет: золотой



Livia $\phi 60$ $\square 50$

blat: szkło hartowane dymione, stelaż: stal nierdzewna, kolor: srebrny
top: smoked tempered glass, frame: stainless steel, color: silver
стол: дымчатое каленое стекло, каркас: нерж. сталь, цвет: серебряный

Livia $\phi 80$ $\square 45$

blat: szkło hartowane transparentne, stelaż: stal nierdzewna, kolor: złoty
top: transparent tempered glass, frame: stainless steel, color: golden
стол: прозрачное каленое стекло, каркас: нерж. сталь, цвет: золотой



Kenzo A 60 120 $\square 45$

Kenzo C 40 120 $\square 78$

Kenzo

blat: szkło hartowane burszynowe, stelaż: stal nierdzewna, kolor: złoty | top: amber tempered glass, frame: stainless steel, color: golden | стол: янтарное каленое стекло, каркас: нерж. сталь, цвет: золотой



Ariana B $\phi 50$ $\square 55$

blat: szkło hartowane burszynowe, stelaż: stal nierdzewna, kolor: złoty
top: amber tempered glass, frame: stainless steel, color: golden
стол: янтарное каленое стекло, каркас: нерж. сталь, цвет: золотой

Clark $\phi 50$ $\square 57$

blat: szkło hartowane dymione, stelaż: stal nierdzewna, kolor: złoty
top: smoked tempered glass, frame: stainless steel, color: golden
стол: дымчатое каленое стекло, каркас: нерж. сталь, цвет: золотой



Azalia Ceramic $\phi 50$ $\square 50$ N

blat: ceramika, stelaż: metal kolor: biały połysk, efekt marmuru / złoty
top: ceramics, frame: metal, color: white high gloss, marble effect / golden
стол: керамика, каркас: металл, цвет: белый лак, э. мрамора / золотой



Crystal A $\phi 80$ $\square 45$



Crystal B $\phi 55$ $\square 55$

Crystal

blat: szkło hartowane burszynowe, stelaż: stal nierdzewna, kolor: srebrny | top: amber tempered glass, frame: stainless steel, color: silver
стол: янтарное каленое стекло, каркас: нерж. сталь, цвет: серебряный



φ80 □42 φ60 □38
φ60 □45 φ45 □40

Portafino A

blat: ceramika, stelaż: stal nierdzewna, kolor: biały połysk, efekt marmuru / złoty
top: ceramics, frame: stainless steel, color: white high gloss, marble effect / golden
стол: керамика, каркас: нерж. сталь, цвет: белый лак, эффект мрамора / золотой



φ80 □42 φ60 □38
φ60 □45 φ45 □40

Portafino B

blat: ceramika, stelaż: stal nierdzewna, kolor: szary połysk, efekt marmuru / chrom
top: ceramics, frame: stainless steel, color: grey high gloss, marble effect / chrome
стол: керамика, каркас: нерж. сталь, цвет: серый лак, эффект мрамора / хром

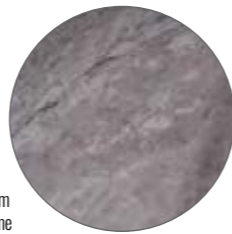

50 □53

Silver B II

blat: szkło hartowane, stelaż: stal nierdzewna, kolor: biały, efekt marmuru / stalowy
top: tempered glass, frame: stainless steel, color: white, marble effect / gunmetal
стол: каленое стекло, каркас: нерж. сталь, цвет: эффект мрамора / стальной



50 □53

Silver B

blat: szkło hartowane dymione, stelaż: stal nierdzewna, kolor: srebrny, złoty | top: smoked tempered glass, frame: stainless steel, color: silver, golden
стол: дымчатое каленое стекло, каркас: нерж. сталь, цвет: серебряный, золотой



φ60 □40 φ80 □45

Muse

blat: szkło hartowane, stelaż: stal nierdzewna, kolor: biały, czarny, efekt marmuru / złoty | top: tempered glass, frame: stainless steel, color: white, black, marble effect / golden
стол: каленое стекло, каркас: нерж. сталь, цвет: белый, черный, эффект мрамора / золотой



φ80 □45

Salma

blat: szkło hartowane, stelaż: stal nierdzewna, kolor: biały, efekt marmuru / złoty
top: tempered glass, frame: stainless steel, color: white, marble effect / golden
стол: каленое стекло, каркас: нерж. сталь, цвет: белый, э. мрамора / золотой



80 □46

Silver A II

blat: szkło hartowane, stelaż: stal nierdzewna, kolor: biały, efekt marmuru / stalowy
top: tempered glass, frame: stainless steel, color: white, marble effect / gunmetal
стол: каленое стекло, каркас: нерж. сталь, цвет: эффект мрамора / стальной



80 □46

Silver A

blat: szkło hartowane dymione, stelaż: stal nierdzewna, kolor: srebrny, złoty | top: smoked tempered glass, frame: stainless steel, color: silver, golden
стол: дымчатое каленое стекло, каркас: нерж. сталь, цвет: серебряный, золотой



φ45 □40 φ60 □45

Muse II

blat: szkło hartowane, stelaż: stal nierdzewna, kolor: biały, czarny, efekt marmuru / złoty | top: tempered glass, frame: stainless steel, color: white, black, marble effect / golden
стол: каленое стекло, каркас: нерж. сталь, цвет: белый, черный, эффект мрамора / золотой



60 □45

Liam

blat: szkło hartowane dymione, stelaż: stal nierdzewna, kolor: złoty
top: smoked tempered glass, frame: stainless steel, color: golden
стол: дымчатое каленое стекло, каркас: нерж. сталь, цвет: золотой



80 □45

Silver A

blat: MDF+okleina naturalna, stelaż: stal nierdzewna, kolor: orzech / srebrny
top: MDF+natural veneer, frame: stainless steel, color: walnut / silver
стол: МДФ+нат. шпон, каркас: нерж. сталь, цвет: орех / серебряный



80 □45

Silver A

blat: MDF+okleina, stelaż: metal, kolor: orzech, dąb artisan / czarny mat | top: MDF+veneer, frame: metal, color: walnut, artisan oak / black mat
стол: МДФ+шпон, каркас: металл, цвет: орех, дуб артизан / черный мат



φ80 □45

Sabine

blat: szkło hartowane, stelaż: stal nierdzewna, kolor: biały, czarny, efekt marmuru / złoty | top: tempered glass, frame: stainless steel, color: white, black, marble effect / golden
стол: каленое стекло, каркас: нерж. сталь, цвет: белый, черный, эффект мрамора / золотой



40 □38 45 □43

Gloria

blat: szkło hartowane, stelaż: stal nierdzewna, kolor: biały, efekt marmuru / złoty
top: tempered glass, frame: stainless steel, color: white, marble effect / golden
стол: каленое стекло, каркас: нерж. сталь, цвет: белый, э. мрамора / золотой



φ60 □45

Agis A

blat: szkło hartowane transparentne, stelaż: metal, kolor: srebrny, złoty, czarny mat | top: transparent tempered glass, frame: metal, color: silver, golden, black mat
стол: прозрачное каленое стекло, каркас: металл, цвет: серебряный, золотой, черный матовый





Flame C



Flame B 55 40 55



Flame C 120 40 78



Versace C 80 40 78

Flame / Versace

blat: szkło hartowane transparentne, stelaż: stal nierdzewna, kolor: srebrny | top: transparent tempered glass, frame: stainless steel, color: silver | стол: прозрачное каленое стекло, каркас: нерж. сталь, цвет: серебряный



Vela A 110 66 43



Vela B 61 61 61



Vela

blat: marmur+okleina, stelaż: stal nierdzewna, kolor: czarny / srebrny | top: marble+veneer, frame: stainless steel, color: black / silver | стол: мрамор+шпон, каркас: нерж. сталь, цвет: черный / серебряный



Fossil A 120 60 40



Fossil B 55 55 55



Fossil C 120 40 78

Fossil

blat: szkło hartowane dymione, stelaż: stal nierdzewna, kolor: srebrny | top: smoked tempered glass, frame: stainless steel, color: silver | стол: дымчатое каленое стекло, каркас: нерж. сталь, цвет: серебряный



Prince A 120 60 45



Prince B 55 55 55



Prince C 120 40 78

Prince

blat: szkło hartowane, stelaż: stal nierdzewna, kolor: czarny / chrom | top: tempered glass, frame: stainless steel, color: black / chrome | столешница: каленое стекло, каркас: нерж. сталь, цвет: черный / хром



Prince A Ceramic 120 60 45



Prince B Ceramic 55 55 55



Prince C Ceramic 120 40 78

Prince Ceramic

blat: ceramika, calacatta, stelaż: stal nierdzewna, kolory: biały / chrom | top: ceramics, calacatta, frame: stainless steel, colors: white / chrome | стол: керамика, calacatta, каркас: нерж. сталь, цвет: белый / хром





Escada A II 120 60 40



Escada B II 55 55 55



Escada C II 120 40 78

Escada II

blat: szkło hartowane, stelaż: stal nierdzewna, kolor: czarny, efekt marmuru / złoty | top: tempered glass, frame: stainless steel, color: black, marble effect / golden | стол: к. стекло, каркас: нерж. сталь, цвет: черный, эффект мрамора / золотой



Escada A III 120 60 40



Escada B III 55 55 55



Escada A 120 60 40

Escada III

blat: ceramika, efekt marmuru, stelaż: metal, kolor: szary połysk / czarny mat | top: ceramics, marble effect, frame: metal, color: grey high gloss / black mat | стол: керамика, эффект мрамора, каркас: металл, цвет: серый лак / черный матовый

blat: MDF+okleina naturalna, stelaż: stal nierdzewna, kolor: orzech / srebrny | top: MDF+natural veneer, frame: stainless steel, color: walnut / silver | стол: МДФ+нат. шпон, каркас: нерж. сталь, цвет: орех / серебряный



Escada A II 120 60 40



Escada B II 55 55 55



Escada C II 120 40 78

Escada II

blat: szkło hartowane, stelaż: stal nierdzewna, kolor: biały, efekt marmuru / złoty | top: tempered glass, frame: stainless steel, color: white, marble effect / golden | стол: к. стекло, каркас: нерж. сталь, цвет: эффект мрамора / золотой



Escada A II 120 60 40



Escada B II 55 55 55



Hilton C 120 40 78

Escada II

blat: szkło hartowane, stelaż: stal nierdz., kolor: biały, efekt marmuru / srebrny | top: tempered glass, frame: stainless steel, color: white, marble effect / silver | стол: к. стекло, каркас: нерж. сталь, цвет: белый, э. мрамора / серебряный

blat: szkło hartowane transparentne, stelaż: stal nierdzewna, kolor: srebrny | top: transparent tempered glass, frame: stainless steel, color: silver | стол: прозрачное каленое стекло, каркас: нерж. сталь, цвет: серебряный



Escada A 120 60 40



Escada B 55 55 55



Elise S 100 30 78

Escada

blat: szkło hartowane dymione, stelaż: stal nierdzewna, kolor: złoty | top: smoked tempered glass, frame: stainless steel, color: golden | стол: дымчатое каленое стекло, каркас: нерж. сталь, цвет: золотой



Escada A 120 60 40



Escada B 55 55 55



Escada C 120 40 78

Escada

blat: szkło hartowane transparentne, stelaż: stal nierdzewna, kolor: srebrny | top: transparent tempered glass, frame: stainless steel, color: silver | стол: прозрачное каленое стекло, каркас: нерж. сталь, цвет: серебряный



Elise A 120 60 40



Elise B 55 55 55



Elise C 120 40 78

Elise

blat: szkło hartowane dymione, stelaż: stal nierdzewna, kolor: złoty | top: smoked tempered glass, frame: stainless steel, color: golden | стол: дымчатое каленое стекло, каркас: нерж. сталь, цвет: золотой



Zegna A 120 60 40



Zegna B 55 55 55



Zegna C 120 40 78

Zegna

blat: szkło hartowane transparentne, stelaż: stal nierdzewna, kolor: srebrny | top: transparent tempered glass, frame: stainless steel, color: silver | стол: прозрачное каленое стекло, каркас: нерж. сталь, цвет: серебряный



Atlanta A $\phi 80$ $\square 45$ $\phi 60$ $\square 42$



Atlanta A II $\phi 53$ $\square 45$ $\phi 43$ $\square 35$



Atlanta A

blat: szkło, stelaż: metal, kolor: szary mat, efekt marmuru / czarny mat | top: glass, frame: metal, color: grey mat, marble effect / black mat | стол: стекло, каркас: металл, цвет: серый, эффект мрамора / черный матовый



Amaro $\phi 53$ $\square 45$ $\phi 43$ $\square 35$

blat: MDF+okleina, stelaż: metal, kolor: dąb / czarny mat
top: MDF+veneer, frame: metal, color: oak / black mat
стол: МДФ+шпон, каркас: металл, цвет: дуб / черный матовый



Amaro $\phi 53$ $\square 45$ $\phi 43$ $\square 35$

blat: MDF+okleina, efekt marmuru, stelaż: metal, kolor: czarny / czarny mat
top: MDF+veneer, marble effect, frame: metal, color: black / black mat
стол: МДФ+шпон, эффект мрамора, каркас: металл, цвет: черный / черный матовый



Atlanta B $\phi 80$ $\square 45$ $\phi 60$ $\square 42$



Atlanta B II $\phi 53$ $\square 45$ $\phi 43$ $\square 35$



Atlanta B

blat: szkło, stelaż: metal, kolor: biały połysk, efekt marmuru / chrom | top: glass, frame: metal, color: white high gloss, marble effect / chrom e | стол: стекло, каркас: металл, цвет: белый лак, эффект мрамора / хром



Atlanta III $\phi 80$ $\square 45$ $\phi 60$ $\square 40$

blat: płyta laminowana, stelaż: metal, kolor: dąb / czarny mat
top: laminated board, frame: metal, color: oak / black mat
стол: ламин, ДСП, каркас: металл, цвет: дуб / черный матовый



Atlanta III $\phi 80$ $\square 45$ $\phi 60$ $\square 40$

blat: MDF+melamina, stelaż: metal, kolor: orzech / chrom
top: MDF+melamine, frame: metal, color: walnut / chrome
стол: МДФ+меламин, каркас: металл, цвет: орех / хром



Atlanta C $\phi 80$ $\square 45$ $\phi 60$ $\square 42$



Atlanta C II $\phi 53$ $\square 45$ $\phi 43$ $\square 35$

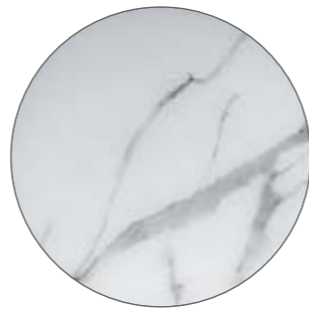

Atlanta C

blat: szkło, stelaż: metal, kolor: biały mat, efekt marmuru / czarny mat | top: glass, frame: metal, color: white mat, marble effect / black mat | стол: стекло, каркас: металл, цвет: белый матовый, эффект мрамора / черный матовый



Ferrante E $\phi 80$ $\square 42$ $\phi 60$ $\square 38$

blat: szkło hart. dymione, stelaż: metal, kolor: szary transparentny / czarny mat
top: smoked temp. glass, frame: metal, color: grey transparent / black mat
стол: дым. каленое стекло, каркас: металл, цвет: серый прозор. / черный матовый



Ferrante C $\phi 80$ $\square 42$ $\phi 60$ $\square 38$

blat: ceramika, stelaż: metal, kolor: biały połysk, efekt marmuru / czarny mat
top: ceramics, frame: metal, color: white high gloss, marble effect / black mat
стол: керамика, каркас: металл, цвет: белый лак, эффект мрамора / черный матовый



Atlanta D $\phi 80$ $\square 45$ $\phi 60$ $\square 42$



Atlanta D II $\phi 53$ $\square 45$ $\phi 43$ $\square 35$



Atlanta D

blat: szkło, stelaż: metal, kolor: czarny połysk / czarny mat | top: glass, frame: metal, color: black high gloss / black mat | стол: стекло, каркас: металл, цвет: черный лак / черный матовый



Ferrante D $\phi 80$ $\square 42$ $\phi 60$ $\square 38$

blat: ceramika, stelaż: metal, kolor: czarny mat, efekt marmuru / czarny mat
top: ceramics, frame: metal, color: black mat, marble effect / black mat
стол: керамика, каркас: металл, цвет: черный матовый, эффект мрамора / черный матовый



Ferrante B $\phi 80$ $\square 42$ $\phi 60$ $\square 38$

blat: ceramika, stelaż: metal, kolor: biały mat, czarny mat, efekt marmuru / czarny mat
top: ceramics, frame: metal, color: white mat, black mat, marble effect / black mat
стол: керамика, каркас: металл, цвет: белый матовый, черный матовый, эффект мрамора / черный матовый

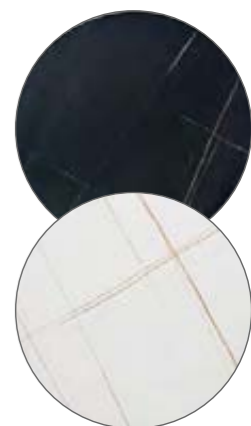



Dion $\phi 80$ \square $\phi 48$ \square $\phi 42$

blat: płyta laminowana, stelaż: metal, kolor: biały, czarny, efekt marmuru, dąb / czarny mat | top: laminated board, frame: metal, color: white, black, marble effect, oak / black mat
 стол: ДСП, каркас: металл, цвет: белый, черный, эффект мрамора, дуб / черный матовый



Twix $\phi 75$ \square $\phi 50$ \square $\phi 45$ **N**

blat: MDF+okleina, stelaż: metal, kolor: orzech vintage, dąb artisan / czarny mat
 top: MDF+veneer, frame: metal, color: vintage walnut, artisan oak / black mat
 стол: МДФ+шпон, каркас: металл, цвет: винтажный орех, дуб artisan / черный мат



Dion $\phi 80$ \square $\phi 48$ \square $\phi 42$

blat: płyta laminowana, stelaż: metal, kolor: biały, czarny, efekt marmuru / złoty | top: laminated board, frame: metal, color: white, black, marble effect / golden
 стол: ДСП, каркас: металл, цвет: белый, черный, эффект мрамора / золотой



Hola / Dion



Hola / Dion



Into $\phi 35$ \square $\phi 40$ \square $\phi 45$ **N**

blat: MDF+okleina, stelaż: metal, kolor: dąb artisan / czarny mat
 top: MDF+veneer, frame: metal, color: artisan oak / black mat
 стол: МДФ+шпон, каркас: металл, цвет: дуб artisan / черный мат



Twingo $\phi 64$ \square $\phi 46$ \square $\phi 54$ **N**

blat: MDF+okleina naturalna, stelaż: metal, kolor: orzech / czarny mat
 top: MDF+natural veneer, frame: metal, color: walnut / black mat
 стол: МДФ+натуральный шпон, каркас: металл, цвет: орех / черный мат



Hola $\phi 45$ \square $\phi 48$ \square $\phi 42$

blat: płyta laminowana, stelaż: metal, kolor: biały, czarny, efekt marmuru / złoty | top: laminated board, frame: metal, color: white, black, marble effect / golden
 стол: ДСП, каркас: металл, цвет: белый, черный, эффект мрамора / золотой



Hola / Dion



Doblo $\phi 60$ \square $\phi 55$ \square $\phi 50$ **N**

blat: MDF+okleina, stelaż: metal, kolor: dąb artisan / czarny mat
 top: MDF+veneer, frame: metal, color: artisan oak / black mat
 стол: МДФ+шпон, каркас: металл, цвет: дуб artisan / черный мат



Hola $\phi 45$ \square $\phi 48$ \square $\phi 42$

blat: płyta laminowana, stelaż: metal, kolor: biały, czarny, efekt marmuru, dąb / czarny mat | top: laminated board, frame: metal, color: white, black, marble effect, oak / black mat
 стол: ДСП, каркас: металл, цвет: белый, черный, эффект мрамора, дуб / черный матовый



Dual $\phi 120$ \square $\phi 49$ **N**

zestaw, blat: MDF+okleina, stelaż: metal, kolor: dąb artisan / czarny mat
 set, top: MDF+veneer, frame: metal, color: artisan oak / black mat
 набор, стол: МДФ+шпон, каркас: металл, цвет: дуб artisan / черный мат



Dual

**Antila** $\phi 80 \square 40$

blat: szkło hartowane, efekt kamienia, stelaż: metal, kolor: brąz / czarny mat
 top: tempered glass, stone effect, frame: metal, color: brown / black mat
 стол: кал. стекло, эффект камня, каркас: металл, цвет: корич. / черный матовый

**Antila** $\phi 80 \square 40$

blat: szkło hartowane, efekt kamienia, stelaż: metal, kolor: szary / czarny mat
 top: tempered glass, stone effect, frame: metal, color: grey / black mat
 стол: каленое стекло, эффект камня, каркас: металл, цвет: серый / черный матовый

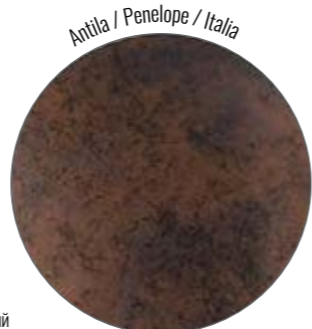

Antila / Penelope / Italia

**Penelope** $\phi 50 \square 45 \phi 50 \square 50$

blat: szkło hartowane, efekt kamienia, stelaż: metal, kolor: brąz+szary / czarny mat
 top: tempered glass, stone effect, frame: metal, color: brown+grey / black mat
 стол: кал. стекло, эффект камня, каркас: металл, цвет: корич.+ серый / черный матовый

**Italia** $\phi 80 \square 50 \phi 60 \square 45$

blat: szkło hartowane, efekt kamienia, stelaż: metal, kolor: brąz / czarny mat
 top: tempered glass, stone effect, frame: metal, color: brown / black mat
 стол: каленое стекло, эффект камня, каркас: металл, цвет: корич. / черный матовый



Antila / Penelope / Italia

**Atena** $\phi 40 \square 44 \phi 45 \square 50$

blat: szkło hartowane, stelaż: metal, kolor: czarny mat
 top: tempered glass, frame: metal, color: black mat
 стол: каленое стекло, каркас: металл, цвет: черный матовый

**Demeter** $\phi 80 \square 40 \phi 50 \square 50 \phi 50 \square 45$

blat: MDF+okleina, stelaż: metal, kolor: szary, efekt betonu / czarny mat
 top: MDF+veneer, frame: metal, color: grey, concrete effect / black mat
 стол: МДФ+шпон, каркас: металл, цвет: серый, эффект бетона / черный матовый

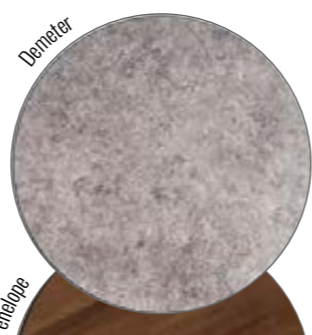

Demeter

Demeter II / Italia II / Penelope

**Demeter II** $\phi 80 \square 50 \phi 50 \square 50 \phi 50 \square 45$

blat: MDF+okleina, stelaż: metal, kolor: orzech / czarny mat
 top: MDF+veneer, frame: metal, color: walnut / black mat
 стол: МДФ+шпон, каркас: металл, цвет: орех / черный матовый

**Italia II** $\phi 80 \square 50 \phi 60 \square 45$

blat: MDF+okleina, stelaż: metal, kolor: orzech / czarny mat
 top: MDF+veneer, frame: metal, color: walnut / black mat
 стол: МДФ+шпон, каркас: металл, цвет: орех / черный матовый

**Penelope** $\phi 50 \square 45 \phi 50 \square 50$

blat: MDF+okleina, stelaż: metal, kolor: orzech / czarny mat
 top: MDF+veneer, frame: metal, color: walnut / black mat
 стол: МДФ+шпон, каркас: металл, цвет: орех / черный матовый



Artemida

**Artemida** $\phi 80 \square 40 \phi 50 \square 50 \phi 50 \square 45$

blat: szkło hartowane, stelaż: metal, kolor: jasny szary+szary+czarny / czarny mat
 top: tempered glass, frame: metal, color: light grey+grey / black mat
 стол: каленое стекло, каркас: металл, цвет: светлый серый+серый / черный матовый

**Italia** $\phi 80 \square 50 \phi 60 \square 45$

blat: szkło hartowane, stelaż: metal, kolor: czarny / czarny mat
 top: tempered glass, frame: metal, color: black / black mat
 стол: каленое стекло, каркас: металл, цвет: черный / черный матовый

**Penelope** $\phi 50 \square 45 \phi 50 \square 50$

blat: szkło hartowane, stelaż: metal, kolor: jasny szary+szary / czarny mat
 top: tempered glass, frame: metal, color: light grey+grey / black mat
 стол: кал. стекло, каркас: металл, цвет: светлый серый+серый / черный матовый



Saga $\phi 45$ $\square 50$ $\phi 40$ $\square 45$

blat: szkło hartowane, stelaż: metal, kolor: czarny / chrom
top: tempered glass, frame: metal, color: black / chrome
столешница: каленое стекло, каркас: металл, цвет: черный / хром



Saga $\phi 45$ $\square 50$ $\phi 40$ $\square 45$

blat: szkło hartowane, stelaż: metal, kolor: czarny / złoty
top: tempered glass, frame: metal, color: black / golden
столешница: каленое стекло, каркас: металл, цвет: черный / золотой



Salva $\phi 60$ $\square 45$ $\phi 45$ $\square 37$

blat: szkło hartowane, stelaż: metal, kolor: czarny / chrom
top: tempered glass, frame: metal, color: black / chrome
столешница: каленое стекло, каркас: металл, цвет: черный / хром



Eos E $\phi 45$ $\square 55$

Eos

blat: MDF+okleina, stelaż: metal, kolor: dąb artisan / czarny mat | top: MDF+veneer, frame: metal, color: artisan oak / black mat | стол: МДФ+шпон, каркас: металл, цвет: дуб artisan / черный мат



Eos D $\phi 60$ $\square 45$



Scarlet $\phi 74$ $\square 40$

Scarlet

blat: szkło hartowane, stelaż: metal, kolor: czarny / chrom, złoty | top: tempered glass, frame: metal, color: black / chrome, golden | столешница: каленое стекло, каркас: металл, цвет: черный / хром, золотой



Scarlet II $\phi 47$ $\square 50$ $\phi 40$ $\square 45$



Eos E $\phi 45$ $\square 55$

Eos

blat: MDF+okleina naturalna, stelaż: metal, kolor: orzech / czarny mat | top: MDF+natural veneer, frame: metal, color: walnut / black mat | стол: МДФ+нат. шпон, каркас: металл, цвет: орех / черный мат



Eos D $\phi 60$ $\square 45$



Mystic B $\phi 82$ $\square 40$

blat: szkło hartowane, kolor: czarny, stelaż: metal, kolor: złoty mat
top: tempered glass, color: black, frame: metal, color: golden mat
стол: каленое стекло, цвет: черный, каркас: металл, цвет: золотой матовый



Gina B $\phi 82$ $\square 40$

blat: szkło hartowane, stelaż: metal, kolor: czarny / miedź
top: tempered glass, frame: metal, color: black / copper
столешница: каленое стекло, каркас: металл, цвет: черный / медь



Ibiza C $\phi 42$ $\square 51$

blat: szkło hartowane, efekt marmuru, stelaż: metal, kolor: złoty
top: tempered glass, marble effect, frame: metal, color: golden
стол.: каленое стекло, эффект мрамора, каркас: металл, цвет: золотой



Eos E $\phi 45$ $\square 55$

Eos

blat: MDF+okleina naturalna, stelaż: metal, kolor: orzech / chrom | top: MDF+natural veneer, frame: metal, color: walnut / chrome | стол: МДФ+нат. шпон, каркас: металл, цвет: орех / хром



Eos D $\phi 60$ $\square 45$



Milos $\phi 41$ $\square 44$ $\phi 42$ $\square 50$

blat: szkło hartowane, stelaż: metal, kolor: czarny / szampańskie
top: tempered glass, frame: metal, color: black / champagne
стол.: каленое стекло, каркас: металл, цвет: черный / шампанское



Delia II $\phi 45$ $\square 45$ $\phi 60$ $\square 52$

blat: szkło hartowane, stelaż: metal, kolor: czarny / chrom
top: tempered glass, frame: metal, color: black / chrome
столешница: каленое стекло, каркас: металл, цвет: черный / хром



Delia II $\phi 45$ $\square 45$ $\phi 59$ $\square 52$

blat: szkło hartowane, efekt marmuru, stelaż: metal, kolor: złoty
top: tempered glass, marble effect, frame: metal, color: golden
стол.: каленое стекло, эффект мрамора, каркас: металл, цвет: золотой



Eos C $\phi 52$ $\square 56$

Eos

blat: szkło hartowane transparentne, stelaż: metal, kolor: chrom | top: transparent tempered glass, frame: metal, color: chrome | столешница: проз. каленое стекло, каркас: металл, цвет: хром



Eos B $\phi 80$ $\square 46$

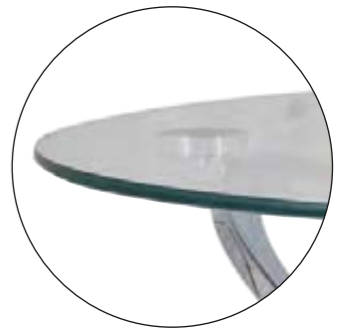



Rossi A 110 60 45



Rossi B 60 60 45



Rossi C 100 30 80

Rossi

blat: płyta laminowana, stelaż: metal, kolor: czarny, efekt marmuru / czarny mat | top: laminated board, frame: metal, color: black, marble effect / black mat | стол: ДСП, каркас: металл, цвет: черный, эф. мрамора / черный мат



Karina A 90 60 41



Karina B 40 40 51



Karina

blat: MDF+melamina, stelaż: metal, kolor: dąb / czarny mat | top: MDF+melamine, frame: metal, color: oak / black mat | стол: МДФ+меламин, каркас: металл, цвет: дуб / черный матовый



Almeria A 60 42



Almeria B 60 45



Vanessa 80 45

Almeria

blat: szkło dymione hartowane, stelaż: metal, kolor: czarny mat | top: smoked tempered glass, frame: metal, color: black mat
стол: дымчатое каленое стекло, каркас: металл, цвет: черный матовый

blat: szkło dymione hartowane, stelaż: metal, kolor: czarny mat
top: smoked tempered glass, frame: metal, color: black mat
стол: дымчатое каленое стекло, каркас: металл, цвет: черный матовый



Lunaria 110 50 47



Afra 100 60 45

blat: MDF+okleina / MDF lakierowany, stelaż: metal, kolor: dąb artisan / antracyt / czarny mat
top: MDF+veneer / painted MDF, frame: metal, color: artisan oak / anthracite / black mat
стол: МДФ+шпон / лакированный МДФ, каркас: металл, цвет: дуб артизан / антрацит / черный матовый

stół / table / стол
blat: płyta laminowana, stelaż: metal, kolor: dąb artisan+antracyt / czarny mat
top: laminated board, frame: metal, color: artisan oak+anthracite / black mat
столешница: ламин, ДСП, каркас: металл, цвет: дуб артизан+антрацит / черный матовый



Osaka A 110 60 50



Osaka B 40 40 50



Osaka C 80 80 50

Osaka

blat: szkło hartowane, stelaż: metal, kolor: czarny mat / czarny | top: tempered glass, frame: metal, color: black / black mat | стол: каленое стекло, каркас: металл, цвет: черный / черный матовый



Lex S 40 40 60



Lex L 45 90 45



Orion 55 55 55

Lex

blat: płyta laminowana, stelaż: metal, kolor: dąb / czarny mat | top: laminated board, frame: metal, color: oak / black mat
столешница: ламин, ДСП, каркас: металл, цвет: дуб / черный матовый

blat: MDF+okleina, stelaż: metal, kolor: dąb / czarny mat
top: MDF+veneer, frame: metal, color: oak / black mat
столешница: МДФ+шпон, каркас: металл, цвет: дуб / черный матовый



Palermo II 60 40 45



Palermo I 60 40 45



Ravello 60 40 50 55

blat: szkło hartowane, efekt marmuru, stelaż: metal, kolor: szary / czarny mat
top: tempered glass, marbleeffect, frame: metal, color: grey / black mat
стол: каленое стекло, эф. мрамора, каркас: металл, цвет: серый / черный матовый

blat: szkło hartowane, efekt drewna stelaż: metal, kolor: jasny brąz / czarny mat
top: tempered glass, wood effect, frame: metal, color: light brown / black mat
стол: каленое стекло, эф. дерева, каркас: металл, цвет: коричневый / черный мат

blat: szkło hartowane, efekt marmuru, stelaż: metal, kolor: czarny / czarny mat
top: tempered glass, marble effect, frame: metal, color: black / black mat
стол: каленое стекло, эф. мрамора, каркас: металл, цвет: черный / черный мат



Largo Duo 50 45 40 40

blat: MDF+okleina, stelaż: metal, kolor: dąb / czarny mat
top: MDF+veneer, frame: metal, color: oak / black mat
столешница: МДФ+шпон, каркас: металл, цвет: дуб / черный матовый



Merida B 50 50 55



Merida C 38 110 80

Merida

blat: MDF+okleina, stelaż: metal, kolor: dąb / czarny mat | top: MDF+veneer, frame: metal, color: oak / black mat
столешница: МДФ+шпон, каркас: металл, цвет: дуб / черный матовый



Liz II 50 30 50
 blat: MDF+okleina naturalna, stelaż: metal, kolor: dąb / czarny mat
 top: MDF+natural veneer, frame: metal, color: oak / black mat
 столешница: МДФ+нат. шпон, каркас: металл, цвет: дуб / черный матовый



Largo C 40 30 60
 blat: MDF+okleina, stelaż: metal, kolor: dąb / czarny mat
 top: MDF+veneer, frame: metal, color: oak / black mat
 столешница: МДФ+шпон, каркас: металл, цвет: дуб / черный матовый



Symphony A 90 50 42
 blat: płyta laminowana, stelaż: metal, kolor: czarny / czarny mat
 top: laminated board, frame: metal, color: black / black mat
 столешница: ламин. ДСП, каркас: металл, цвет: черный / черный матовый



Symphony B 50 50 50



Symphony C 110 30 70



Symphony D 45 30 60

Symphony 50 50 50
 blat: płyta laminowana, stelaż: metal, kolor: czarny / czarny mat | top: laminated board, frame: metal, color: black / black mat | столешница: ламин. ДСП, каркас: металл, цвет: черный / черный матовый



Harmony A 110 55 42



Harmony B 50 50 50



Harmony C 110 40 80

Harmony

blat: transp. szkło hartowane, stelaż: metal+płyta lam., kolor: czarny mat / orzech | top: transp. tempered glass, frame: metal+lam. board, color: black mat / walnut
 стол: проз. кал. стекло+МДФ лак., кал. стекло+МДФ+шпон, каркас: металл+ламин. ДСП, цвет: черный матовый / орех



Lagos B 53 53 30



Lagos A 100 60 39



Wendy B 48 48 40 40 39

Lagos

blat: płyta laminowana, stelaż: metal, kolor: dąb+czarny / czarny mat | top: laminated board, frame: metal, color: oak+black / black mat
 столешница: ламин. ДСП, каркас: металл, цвет: дуб+черный / черный матовый

blat: płyta laminowana, stelaż: metal, kolor: brąz rustykalny / czarny mat
 top: laminated board, frame: metal, color: rustic brown / black mat
 стол: ДСП, каркас: металл, цвет: деревенский коричневый / черный матовый



2 szuflady / 2 drawers / 2 ящика



Carlo A 110 55 42

blat: szkło hartowane+lakierowany MDF, szkło hartowane+MDF+okleina, stelaż: metal, kolor: czarny / czarny mat, dąb / czarny mat
 top: tempered glass+laquered MDF, tempered glass+MDF+veneer, frame: metal, color: black / black mat, oak / black mat
 стол: каленое стекло+МДФ лак., кал. стекло+МДФ+шпон, каркас: металл, цвет: черный / черный матовый, дуб / черный матовый



Amber B 55 55 42



Amber A 100 60 55

Amber

blat: MDF+melamina, stelaż: metal, kolor: dąb / czarny mat | top: MDF+melamine finish, frame: metal, color: oak / black mat
 столешница: МДФ+меламин, каркас: металл, цвет: дуб / черный матовый



Polaris 121 61 45 N

blat: ceramika, stelaż: metal, kolor: biały mat, efekt marmuru / czarny mat
 top: ceramics, frame: metal, color: white mat, marble effect / black mat
 стол: керамика, каркас: металл, цвет: белый матовый, эффект мрамора / черный матовый



Laguna



Laguna B 110 50 42 N



Laguna A 45 45 48 N



Laguna

blat: szkło hartowane, stelaż: metal, kolor: czarny mat+zloty | top: tempered glass, frame: metal, color: black mat+golden | стол: стекло, каркас: металл, цвет: черный матовый+золотой



Prima A 120 58 43



Prima B 74 74 43

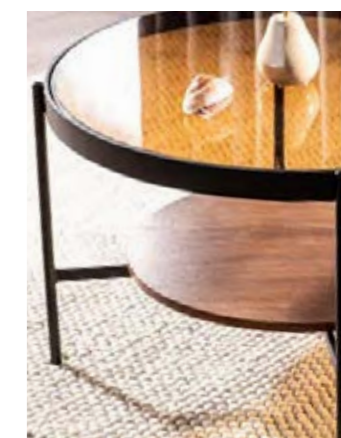

Prima

blat: szkło hartowane bursztynowe+MDF+okleina naturalna, stelaż: metal, kolor: orzech / czarny mat | top: amber tempered glass+MDF+natural veneer, frame: metal, color: walnut / black mat | стол: янтарное каленое стекло+МДФ+нат. шпон, каркас: металл, цвет: орех / черный матовый



Prima



Bahama 80 45 N

blat: szkło hartowane dymione, stelaż: metal, kolor: brąz / czarny mat | top: smoked tempered glass, frame: metal, color: brown / black mat | стол: дымчатое стекло, каркас: металл, цвет: коричневый / черный матовый



Tuca 80 40

blat: MDF+okleina jesionowa, stelaż: metal, kolor: ciemny orzech / czarny mat | top: MDF+ash veneer, frame: metal, color: dark walnut / black mat | стол: МДФ+ясневый шпон, каркас: металл, цвет: темный орех / черный матовый



Ella B 60 45



Ella A 80 45



Ella

blat: płyta laminowana, stelaż: metal, kolor: brąz rustykalny / czarny mat | top: laminated board, frame: metal, color: rustic brown / black mat | столешница: ламин, ДСП, каркас: металл, цвет: коричневый / черный матовый



Step 80 45 60 40 N

blat: ceramika, stelaż: metal, kolor: biały połysk / czarny mat
top: ceramics, frame: metal, color: white high gloss / black mat
стол: керамика, каркас: металл, цвет: белый лак / черный матовый

Step 80 45 60 40 N

blat: ceramika, stelaż: metal, kolor: szary połysk / czarny mat
top: ceramics, frame: metal, color: grey high gloss / black mat
стол: керамика, каркас: металл, цвет: серый лак / черный матовый



Vetro 80 55 60 42 N

blat: ceramika, stelaż: metal, kolor: biały połysk / czarny mat
top: ceramics, frame: metal, color: white high gloss / black mat
стол: керамика, каркас: металл, цвет: белый лак / черный матовый

Vetro 80 55 60 42 N

blat: ceramika, stelaż: metal, kolor: szary połysk / czarny mat
top: ceramics, frame: metal, color: grey high gloss / black mat
стол: керамика, каркас: металл, цвет: серый лак / черный матовый



Kora C 80 45 60 40

blat: ceramika, stelaż: metal, kolor: szary połysk / czarny mat
top: ceramics, frame: metal, color: grey high gloss / black mat
стол: керамика, каркас: металл, цвет: серый лак / черный матовый

Kora D 80 45 60 40

blat: ceramika, stelaż: metal, kolor: biały połysk, efekt marmuru / czarny mat
top: ceramics, frame: metal, color: white high gloss, marble effect / black mat
стол: керамика, каркас: металл, цвет: белый лак, эффект мрамора / черный матовый



Kora B 80 45 60 40

blat: ceramika, stelaż: metal, kolor: biały, czarny mat, efekt marmuru / czarny mat
top: ceramics, frame: metal, color: white, black mat, marble effect / black mat
стол: керамика, каркас: металл, цвет: белый, черный матовый, эффект мрамора / черный матовый



Twin 40 48 60 40

blat: MDF+okleina, stelaż: metal, kolor: orzech / czarny mat
top: MDF+veneer, frame: metal, color: walnut / black mat
стол: МДФ+шпон, каркас: металл, цвет: орех / черный мат

Twin 40 48 60 40

blat: MDF+okleina, stelaż: metal, kolor: dąb artisan / czarny mat
top: MDF+veneer, frame: metal, color: artisan oak / black mat
стол: МДФ+шпон, каркас: металл, цвет: дуб artisan / черный мат



Alta B 45 50

Alta A 80 44

Envo A 122 67 35

Alta

blat: płyta+okleina, stelaż: metal, kolor: orzech / chrom | top: board+veneer, frame: metal, color: walnut / chrome
стол: ДСП+шпон, каркас: металл, цвет: орех / хром

blat: MDF+okleina, stelaż: metal, kolor: orzech / czarny mat
top: MDF+veneer, frame: metal, color: walnut / black mat
стол: МДФ+шпон, каркас: металл, цвет: орех / черный ма

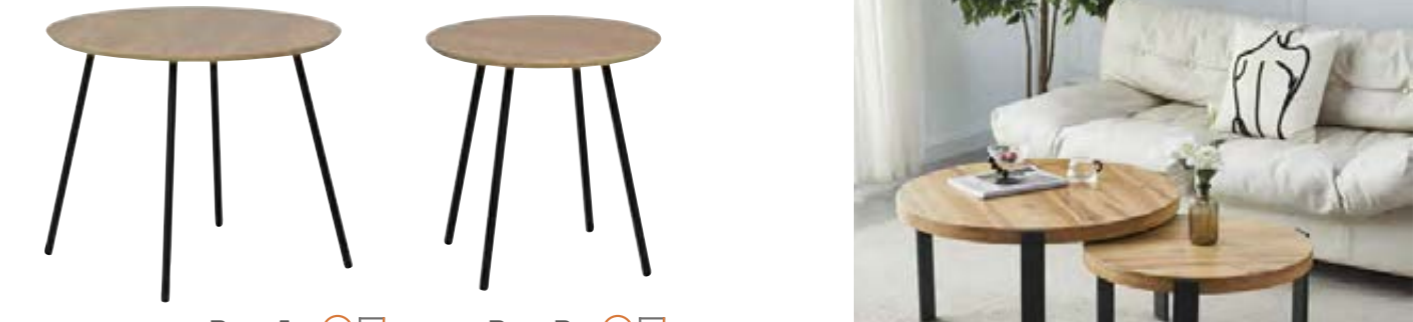

Pam A 55 45

Pam B 40 40

Pam

blat: płyta laminowana, stelaż: metal, kolor: dąb / czarny mat | top: laminated board, frame: metal, color: oak / black mat
столешница: ДСП, каркас: металл, цвет: дуб / черный матовый



Kron 80 41 N

blat: MDF+okleina, stelaż: metal, kolor: dąb artisan / czarny mat
top: MDF+veneer, frame: metal, color: artisan oak / black mat
стол: МДФ+шпон, каркас: металл, цвет: дуб artisan / черный мат

Polo 80 45 60 40 N

blat: MDF+okleina, stelaż: metal, kolor: dąb artisan / czarny mat
top: MDF+veneer, frame: metal, color: artisan oak / black mat
стол: МДФ+шпон, каркас: металл, цвет: дуб artisan / черный мат



Fabia C $\phi 45$ $\square 50$
 blat: szkło hartowane, stelaż: metal, kolor: czarny / chrom
 top: tempered glass, frame: metal, color: black / chrome
 столешница: каленое стекло, каркас: металл, цвет: черный / хром



Trinity $\phi 35$ $\square 46$ $\phi 45$ $\square 51$ $\phi 55$ $\square 56$
 blat: szkło hartowane transparentne, stelaż: stal nierdzewna, kolor: srebrny
 top: transparent tempered glass, frame: stainless steel, color: silver
 стол: прозрачное каленое стекло, каркас: нерж. сталь, цвет: серебряный



Vicky $\square 40$ $\square 35$ $\square 31$ $\square 46$
 blat: metal, stelaż: metal, kolor: ciemny szary, szary, biały
 top: metal, frame: metal, color: dark grey, grey, white
 стол: металл, каркас: металл, цвет: темный серый, серый, белый



Oslo S2 $\phi 50$ $\square 45$ $\phi 40$ $\square 40$
 blat: szkło hartowane / stelaż: metal+okleina, kolor: dąb
 top: tempered glass / frame: metal+veneer, color: oak
 столешница: каленое стекло / каркас: металл+шпон, цвет: дуб



Oslo L2 $\phi 80$ $\square 45$
 blat: szkło hartowane / stelaż: metal+okleina, kolor: dąb
 top: tempered glass / frame: metal+veneer, color: oak
 столешница: каленое стекло / каркас: металл+шпон, цвет: дуб



Milan S2 $\phi 50$ $\square 45$ $\phi 40$ $\square 40$
 blat: MDF, stelaż: metal+okleina, kolor: biały / dąb
 top: MDF, frame: metal+veneer, color: white / oak
 столешница: МДФ, каркас: металл+шпон, цвет: белый / дуб



Muna $\phi 50$ $\square 55$
 blat: szkło hartowane transp., stelaż: metal chromowany
 top: transp. tempered glass, frame: chromed metal
 стол: прозрачное каленое стекло, каркас: хром, металл



Epi $\square 42$ $\square 49$
 szkło transparentne
 transparent glass
 прозрачное стекло



Symphony G $\square 40$ $\square 61$ **N**
 blat: szkło hartowane, stelaż: metal, kolor: biały, efekt marmuru / złoty
 top: tempered glass, frame: metal, color: white, marble effect / golden
 стол: каленое стекло, каркас: металл, цвет: белый, эффект мрамора / золотой



Bora C $\phi 42$ $\square 46$
 blat: lustrzany, stelaż: metal, kolor: chrom
 top: mirror, frame: metal, color: chrome
 столешница: зеркало, каркас: металл, цвет: хром



Cleo $\phi 40$ $\square 45$ $\phi 50$ $\square 50$
 blat: MDF, stelaż: metal malowany, kolor: czarny, biały
 top: MDF, frame: painted metal, color: black, white
 стол: МДФ, каркас: крашенный металл, цвет: черный, белый



Gloria II $\square 40$ $\square 44$ $\square 35$ $\square 37$ **N**
 blat: szkło hartowane, stelaż: metal, kolor: biały, efekt marmuru / złoty
 top: tempered glass, frame: metal, color: white, marble effect / golden
 стол: каленое стекло, каркас: металл, цвет: белый, эффект мрамора / золотой



Gloria II $\square 40$ $\square 44$ $\square 35$ $\square 37$ **N**
 blat: szkło hartowane, stelaż: metal, kolor: biały, efekt marmuru / chrom
 top: tempered glass, frame: metal, color: white, marble effect / chrom
 стол: каленое стекло, каркас: металл, цвет: белый, эффект мрамора / хром



Dolores B $\phi 80$ $\square 42$



Dolores C $\phi 50$ $\square 55$

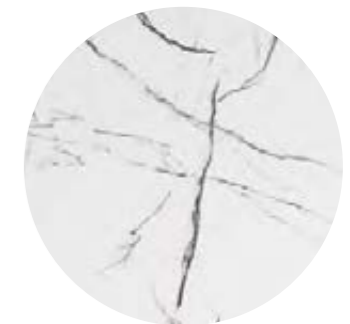

Dolores

blat: MDF+okleina, stelaż: metal, kolor: biały, efekt marmuru / szary | top: MDF+veneer, frame: metal, color: white, marble effect / grey | стол: МДФ+шпон, каркас: металл, цвет: белый, эффект мрамора / серый



Vega B $\phi 80$ $\square 45$



Vega C $\phi 45$ $\square 50$



Vega

blat: szkło+okleina, stelaż: metal, kolor: biały, efekt marmuru / czarny mat+złoty | top: glass+veneer, frame: metal, color: white, marble effect / black mat+golden
 стол: szkło+шпон, каркас: металл, цвет: белый, эффект мрамора / черный матовый+золотой



Quadra 67 50



Gema 64 100 50



Marea 64 100 50

Quadra / Gema / Marea

blat: płyta lam., stelaż: płyta lam., kolor: dąb wotan / czarny mat
top: lam. board, frame: lam. board, color: wotan oak / black mat
столешница: ламин. ДСП, каркас: ламин. ДСП, цвет: дуб вотан / черный матовый



dąb artisan / antracyt

Agava 68 42 N

blat: płyta laminowana, stelaż: płyta laminowana, kolor: old wood / materia c. szary, dąb artisan / antracyt
top: laminated board, frame: laminated board, color: old wood / materia d. grey, artisan oak / anthracite
столешница: ламин. ДСП, каркас: ламин. ДСП, цвет: old wood / materia t. серый, дуб артисан / антрацит



old wood / materia c. szary



Ego 65 50

blat: płyta lam., stelaż: płyta lam., kolor: dąb wotan / czarny mat
top: lam. board, frame: lam. board, color: wotan oak / black mat
столешница: ламин. ДСП, каркас: ламин. ДСП, цвет: дуб вотан / черный матовый



Platon 50 90 46 N

blat: płyta laminowana, stelaż: płyta laminowana, kolor: dąb wotan, dąb artisan / czarny mat, brąz
top: laminated board, frame: laminated board, color: wotan oak, artisan oak / black mat, brown
столешница: ламин. ДСП, каркас: ламин. ДСП, цвет: дуб вотан, дуб артисан / черный матовый, коричневый



dąb artisan / antracyt



old wood / materia c. szary

Agava 50 90 42 N

blat: płyta laminowana, stelaż: płyta laminowana, kolor: old wood / materia c. szary, dąb artisan / antracyt
top: laminated board, frame: laminated board, color: old wood / materia d. grey, artisan oak / anthracite
столешница: ламин. ДСП, каркас: ламин. ДСП, цвет: old wood / materia t. серый, дуб артисан / антрацит



Crocus 50 90 46 N

blat: płyta laminowana, stelaż: płyta laminowana, kolor: dąb artisan / czarny mat
top: laminated board, frame: laminated board, color: artisan oak / black mat
столешница: ламин. ДСП, каркас: ламин. ДСП, цвет: дуб артисан / черный матовый



Calipso 50 90 46 N

blat: płyta laminowana, stelaż: płyta laminowana, kolor: biały mat / szary efekt betonu
top: laminated board, frame: laminated board, color: white mat grey / concrete effect
столешница: ламин. ДСП, каркас: ламин. ДСП, цвет: белый матовый / серый эффект бетона



old wood / materia c. szary



szary efekt betonu / biały mat



dąb artisan / antracyt

Almond 55 100 42 N

blat: płyta laminowana, stelaż: płyta laminowana, kolor: old wood / materia c. szary, dąb artisan / antracyt, szary efekt betonu / biały mat
top: laminated board, frame: laminated board, color: old wood / materia d. grey, artisan oak / anthracite, grey concrete effect / white mat
столешница: ламин. ДСП, каркас: ламин. ДСП, цвет: old wood / materia t. серый, дуб артисан / антрацит, серый эффект бетона / белый матовый



Marina 68 50



Dafne 60 100 50



Evita 60 100 50

Marina / Dafne / Evita

blat: płyta laminowana, stelaż: płyta laminowana, kolor: dąb artisan / czarny mat | top: laminated board, frame: laminated board, color: artisan oak / black mat
столешница: ламин. ДСП, каркас: ламин. ДСП, цвет: дуб артисан / черный матовый



old wood / materia c. szary



dąb wotan / antracyt



dąb artisan

Cotto 67 33 N

blat: płyta laminowana, stelaż: płyta laminowana, kolor: old wood / materia c. szary, dąb artisan / antracyt, dąb wotan
top: laminated board, frame: laminated board, color: old wood / materia d. grey, artisan oak / anthracite, wotan oak
столешница: ламин. ДСП, каркас: ламин. ДСП, цвет: old wood / materia t. серый, дуб артисан / антрацит, дуб вотан





Lisa Basic II 60 100 55

blat: szkło hart. transp., stelaż: MDF, kolor: dąb sonoma
top: transp. tempered glass, frame: MDF, color: sonoma oak
столешница: проз. каленое стекло, каркас: МДФ, цвет: дуб сонома



Lisa Basic II 60 100 55

blat: szkło hart. transp., stelaż: MDF, kolor: wenge
top: transp. tempered glass, frame: MDF, color: wenge
столешница: проз. каленое стекло, каркас: МДФ, цвет: венге



Lisa Basic II 60 100 55

blat: szkło hart. transp., stelaż: MDF, kolor: biały lakier
top: transp. tempered glass, frame: MDF, color: white high gloss
столешница: проз. каленое стекло, каркас: МДФ, цвет: белый лак



Royal D 60 50

blat: MDF+formir / MDF, stelaż: drewno, kolory: c. orzech, biały
top: MDF+natural veneer / MDF, frame: wood, colors: d. walnut, white
стол: МДФ+нат. шпон / МДФ, каркас: древесина, цвет: т. орех, белый



Nevada D 60 55

blat: MDF+formir / MDF, stelaż: drewno, kolory: c. orzech, biały
top: MDF+natural veneer / MDF, frame: wood, colors: d. walnut, white
стол: МДФ+нат. шпон / МДФ, каркас: древесина, цвет: т. орех, белый



Lisa II 60 110 55

blat: szkło hart. transp.+czarny, stelaż: MDF, kolor: biały lakier
top: transp.+black tempered glass, frame: MDF, color: white high gloss
столешница: проз.+ чер. каленое стекло, каркас: МДФ, цвет: белый лак



Lisa II 60 110 55

blat: czarne szkło hartowane, stelaż: MDF, kolor: czarny lakier
top: black tempered glass, frame: MDF, color: black high gloss
столешница: черное каленое стекло, каркас: МДФ, цвет: черный лак



Padova C 45 45 55

blat: MDF+formir, stelaż: drewno, kolor: c. orzech
top: MDF+natural veneer, frame: wood, color: d. walnut
стол: МДФ+нат. шпон, каркас: древесина, цвет: т. орех



Padova D 40 104 75

blat: MDF+formir, stelaż: drewno, kolor: c. orzech
top: MDF+natural veneer, frame: wood, color: d. walnut
стол: МДФ+нат. шпон, каркас: древесина, цвет: т. орех



California D 60 55

blat: MDF+formir, stelaż: drewno, kolor: c. orzech
top: MDF+natural veneer, frame: wood, color: d. walnut
стол: МДФ+нат. шпон, каркас: древесина, цвет: т. орех



Lisa D 60 60 55

blat: szkło hart. transp.+czarne, stelaż: MDF, kolor: beton
top: transp. tempered glass+black, frame: MDF, color: concrete
столешница: проз. каленое стекло+черный, каркас: МДФ, цвет: бетон



Lisa D 60 60 55

blat: szkło hart. transp.+czarne, stelaż: MDF, kolor: biały lakier
top: transp. tempered glass+black, frame: MDF, color: white high gloss
столешница: проз. каленое стекло+черный, каркас: МДФ, цвет: белый лак



Lisa D 60 60 55

blat: czarne szkło hartowane, stelaż: MDF, kolor: czarny lakier
top: black tempered glass, frame: MDF, color: black high gloss
столешница: черные проз. каленое стекло, каркас: МДФ, цвет: черный лак



Daniel 70 120 160 61(75)

blat: płyta laminowana, stelaż: drewno, kolory: wenge, orzech, olcha, kasztan
top: laminated board, frame: wood, colors: wenge, walnut, alder, chestnut
столешница: ламин. ДСП, каркас: древесина, цвет: венге, орех, ольха, каштан

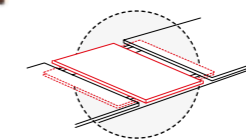

Rava C 60 100 55

blat: szkło hartowane transp.+czarne, stelaż: metal chromowany
top: transp. tempered glass+black, frame: chromed metal
стол.: проз.+черное каленое стекло, каркас: хром, металл



Irene 45 75 45

blat: szkło hartowane transparentne+czarne, stelaż: metal chromowany
top: transparent tempered glass+black, frame: chromed metal
столешница: прозрачное+черное каленое стекло, каркас: хром, металл



Priam A 60 120 42

szkło transparentne
transparent glass
прозрачное стекло



Beata 67 130 170 60(77)

blat: płyta laminowana, stelaż: drewno, kolory: wenge, orzech, dąb sonoma, kasztan
top: laminated board, frame: wood, colors: wenge, walnut, sonoma oak, chestnut
столешница: ламин. ДСП, каркас: древесина, цвет: венге, орех, дуб сонома, каштан

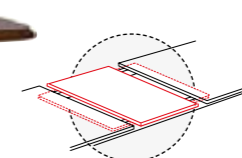

Kleopatra 64 124 164 59(71)

blat: płyta laminowana, stelaż: drewno, kolory: dąb sonoma, dąb lancetot+biały półmat
top: laminated board, frame: wood, colors: sonoma oak, lancetot oak+white semi mat
столешница: ламин. ДСП, каркас: древесина, цвет: дуб сонома, дуб ланселот +белый полуматовый

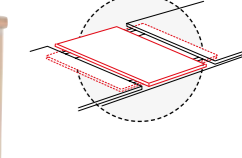









Azalia Velvet



Azalia Brego 86 | 44 | 61 | 50

tkanina Brego | fabric Brego | ткань Brego
metal, czarny mat | metal, black mat | металл, черный матовый



Azalia Velvet 86 | 44 | 61 | 50

tkanina aksamit: Bluvel | velvet fabric: Bluvel | ткань бархат: Bluvel
metal, czarny mat | metal, black mat | металл, черный матовый



Azalia Buffalo 86 | 44 | 61 | 50

skóra syntetyczna Buffalo | synthetic leather Buffalo | искусственная кожа Buffalo
metal, czarny mat | metal, black mat | металл, черный матовый



szary 11 | grey 11

beż 34 | beige 34

curry 66 | curry 66

Coco II Vardo 87 | 45 | 60 | 48 N

tkanina Vardo | fabric Vardo | ткань Vardo
metal, czarny mat | metal, black mat | металл, черный матовый



szary 11 | grey 11

beż 34 | beige 34

curry 66 | curry 66

Coco I Vardo 87 | 43 | 49 | 49 N

tkanina Vardo | fabric Vardo | ткань Vardo
metal, czarny mat | metal, black mat | металл, черный матовый



czarny 19 | black 19

szary 14 | grey 14

beż 28 | beige 28

Boogie I Velvet 89 | 45 | 53 | 50

tkanina aksamit: Bluvet | velvet fabric: Bluvet | ткань бархат: Bluvet
metal, czarny mat | metal, black mat | металл, черный матовый



czarny 19 | black 19

szary 14 | grey 14

beż 28 | beige 28

Boogie II Velvet 89 | 45 | 60 | 50

tkanina aksamit: Bluvet | velvet fabric: Bluvet | ткань бархат: Bluvet
metal, czarny mat | metal, black mat | металл, черный матовый



Coco



Linea Velvet 82 43 59 48

tkanina aksamit: Bluvel | velvet fabric: Bluvel | ткань бархат: Bluvel
metal, czarny mat | metal, black mat | металл, черный матовый



Lilia Velvet 90 45 59 51

tkanina aksamit: Bluvel | velvet fabric: Bluvel | ткань бархат: Bluvel
metal, czarny mat | metal, black mat | металл, черный матовый

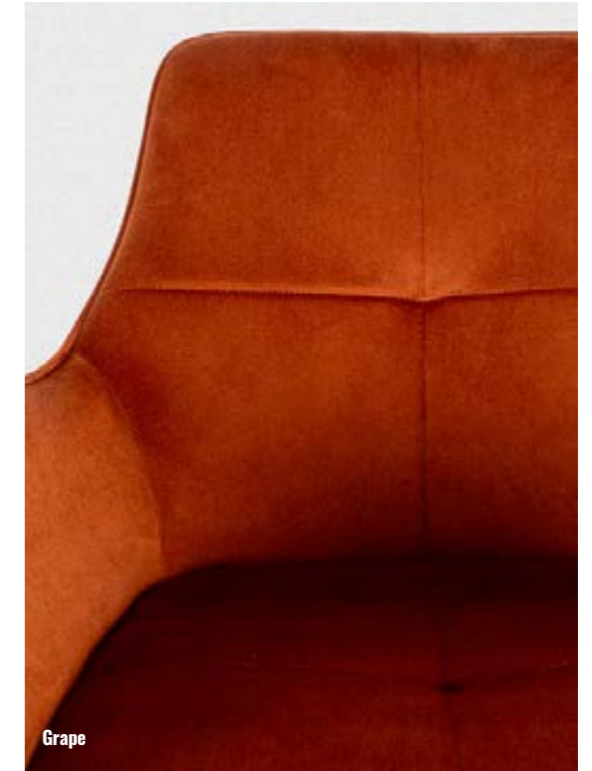
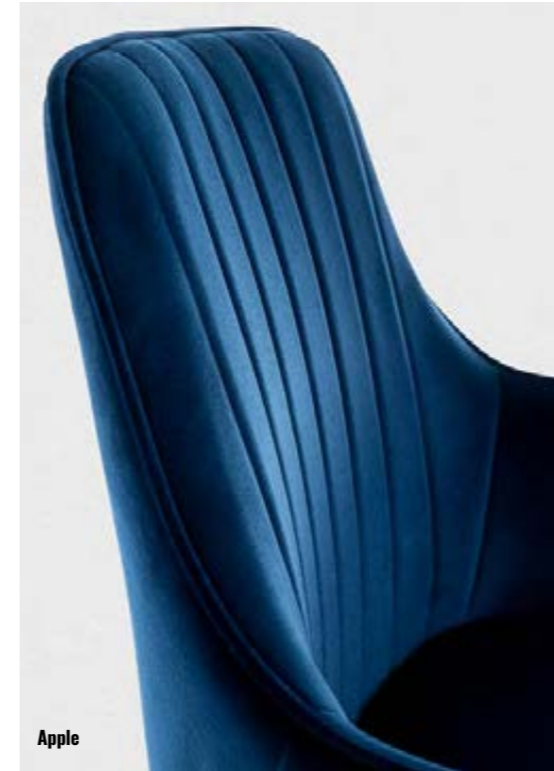





jasny szary 03 | light grey 03

180°
AUTO-RETURN



czarny 19 | black 19

szary 14 | grey 14

ciemny beż 40 | dark beige 40

Astoria II Velvet 85 | 45 | 60 | 48

tkanina aksamit: Bluvel | velvet fabric: Bluvel | ткань бархат: Bluvel
metal, czarny mat | metal, black mat | металл, черный матовый



oliwka 77 | olive 77

180°
AUTO-RETURN



ciemny beż 40 | dark beige 40

szary 14 | grey 14

czarny 19 | black 19

Mango Velvet 83 | 45 | 57 | 49

tkanina aksamit: Bluvel | velvet fabric: Bluvel | ткань бархат: Bluvel
metal, czarny mat | metal, black mat | металл, черный матовый



jasny szary 03 | light grey 03

oliwka 77 | olive 77

szary 14 | grey 14

ciemny beż 40 | dark beige 40

Nuxe Velvet 83 | 42 | 56 | 49

tkanina aksamit: Bluvel | velvet fabric: Bluvel | ткань бархат: Bluvel
metal, czarny mat+chrom | metal, black mat+chrome | металл, черный матовый+хром



grafit 19 | graphite 19

180°
AUTO-RETURN



szary 11 | grey 11

ciemny beż 35 | dark beige 35

curry 66

Mango Vardo 83 | 45 | 57 | 49 N

tkanina Vardo | fabric Vardo | ткань Vardo
metal, czarny mat | metal, black mat | металл, черный матовый



szary 14 | grey 14

granatowy 86 | dark blue 86

zielony 78 | green 78

Ricardo Velvet 87 | 45 | 47 | 47

tkanina aksamit: Bluvel | velvet fabric: Bluvel | ткань бархат: Bluvel
metal, Bluvel | metal, Bluvel | металл, Bluvel



ciemny szary 18 | dark grey 18

beż 34 | beige 34

oliwka 77 | olive 77

Ballo Brego 84 | 45 | 56 | 48

tkanina Brego | fabric Brego | ткань Brego
metal, czarny mat | metal, black mat | металл, черный матовый



oliwka 10 | olive 10

Spello 85 | 41 | 58 | 49

skóra syntetyczna Buffalo | synthetic leather Buffalo | искусственная кожа Buffalo
metal, czarny mat | metal, black mat | металл, черный матовый

360°
AUTO-RETURN



szary, tap. 06 | grey, up. 06

Ricardo 87 | 45 | 47 | 47

tkanina | fabric | ткань
metal+tkanina | metal+fabric | металл+ткань



curry 66

szary 11 | grey 11

ciemny beż 35 | dark beige 35

Capri Vardo 85 | 44 | 56 | 48 N

tkanina Vardo | fabric Vardo | ткань Vardo
metal, czarny mat | metal, black mat | металл, черный матовый



Bono



beż 28 | beige 28

szary 14 | grey 14 czarny 19 | black 19

czarny 19 | black 19

beż 28 | beige 28

Bono Velvet 77 | 44 | 55 | 47 | N

tkanina aksamit: Bluvel | velvet fabric: Bluvel | ткань бархат: Bluvel
metal, czarny mat | metal, black mat | металл, черный матовый

Bono Velvet 77 | 44 | 55 | 47 | N

tkanina aksamit: Bluvel | velvet fabric: Bluvel | ткань бархат: Bluvel
metal, zloty | metal, golden | металл, золотой



szary, tap. 232 | grey, up. 232

beż, tap. 231 | beige, up. 231

Elton 80 | 46 | 56 | 49 | N

tkanina | fabric | ткань
metal, czarny mat | metal, black mat | металл, черный матовый

szary, tap. 156 | grey, up. 156

Prado 83 | 46 | 59 | 50

tkanina | fabric | ткань
metal, zloty | metal, golden | металл, золотой



szary 14 | grey 14

curry 68

Norte Velvet 75 | 40 | 76 | 51

tkanina aksamit: Bluvel | velvet fabric: Bluvel | ткань бархат: Bluvel
metal, czarny mat | metal, black mat | металл, черный матовый



szary 14 | grey 14

curry 68

Nuvo Velvet 86 | 47 | 62 | 50

tkanina aksamit: Bluvel | velvet fabric: Bluvel | ткань бархат: Bluvel
metal, czarny mat | metal, black mat | металл, черный матовый



zawiera poduszkę



jasny beż 24 | light beige 24

szary 13 | grey 13

curry 68 | curry 68

ciemny szary 16 | dark grey 16



Tello Bjorn 84 | 46 | 54 | 48 N

tkanina Bjorn | fabric Bjorn | ткань Bjorn
metal, czarny mat | metal, black mat | металл, черный матовый



szary 07 | grey 07

wrzosowy 93 | lilac 93

ciemny szary 18 | dark grey 18

beż 34 | beige 34



Asti Brego 88 | 45 | 52 | 48 N

tkanina Brego | fabric Brego | ткань Brego
metal, czarny mat | metal, black mat | металл, черный матовый



szary 11 | grey 11

oliwka 74 | olive 74

beż 34 | beige 34



Coda Vardo 91 | 46 | 56 | 50 N

tkanina Vardo | fabric Vardo | ткань Vardo
metal, czarny mat | metal, black mat | металл, черный матовый



ciemny szary 16 | dark grey 16

jasny beż 24 | light beige 24

cypramon 42 | cinnamon 42



Kenzie Bjorn 91 | 46 | 51 | 48 N

tkanina Bjorn | fabric Bjorn | ткань Bjorn
metal, czarny mat | metal, black mat | металл, черный матовый



Tello

Coda



Asti



Jake / Frank / Mike



Jake Nea 86 41 49 47 N

tkanina: Nea | fabric: Nea | ткань: Nea
metal, czarny mat | metal, black mat | металл, черный матовый



Frank Nea 86 41 48 47 N

tkanina: Nea | fabric: Nea | ткань: Nea
metal, czarny mat | metal, black mat | металл, черный матовый



Mike Nea 86 41 48 47 N

tkanina: Nea | fabric: Nea | ткань: Nea
metal, czarny mat | metal, black mat | металл, черный матовый



Frank



Mike



Jerry Velvet 91 39 45 51

tkanina aksamit: Bluelvel | velvet fabric: Bluelvel | ткань бархат: Bluelvel
metal, czarny mat | metal, black mat | металл, черный матовый



Agat



Agat



Swing



Swing



oliwka 77 | olive 77

beż 34 | beige 34

ciemny szary 18 | dark grey 18

szary 07 | grey 07

Swing Brego 90 | 43 | 50 | 49 | N

tkanina Brego | fabric Brego | ткань Brego
metal, czarny mat | metal, black mat | металл, черный матовый



ciemny beż 40 | dark beige 40

granatowy 86 | dark blue 86

szary 14 | grey 14

czarny 19 | black 19

Agat Velvet 88 | 44 | 51 | 50 | N

tkanina aksamit: Bluvel | velvet fabric: Bluvel | ткань бархат: Bluvel
metal, czarny mat | metal, black mat | металл, черный матовый



oliwka 77 | olive 77

jasny szary 03 | light grey 03

szary 14 | grey 14

czarny 19 | black 19

ciemny beż 40 | dark beige 40

Ralph Velvet 88 | 42 | 51 | 49

tkanina aksamit: Bluvel | velvet fabric: Bluvel | ткань бархат: Bluvel
metal, czarny mat | metal, black mat | металл, черный матовый



czarny 19 | black 19

turkusowy 85 | turquoise 85

szary 14 | grey 14

zielony 78 | green 78

Kim Velvet 88 | 42 | 47 | 49

tkanina aksamit: Bluvel | velvet fabric: Bluvel | ткань бархат: Bluvel
metal, czarny mat | metal, black mat | металл, черный матовый



szary 07 | grey 07

ciemny szary 18 | dark grey 18

curry 68

beż 34 | beige 34

oliwka 77 | olive 77

Chic Brego 88 | 43 | 50 | 49

tkanina Brego | fabric Brego | ткань Brego
metal, czarny mat | metal, black mat | металл, черный матовый



beż 28 | beige 28

zielony 78 | green 78

czarny 19 | black 19

granatowy 86 | dark blue 86

szary 14 | grey 14

antyczny róż 52 | antique pink 52

Chic Złoty Velvet 88 | 43 | 50 | 49

tkanina aksamit: Bluvel | velvet fabric: Bluvel | ткань бархат: Bluvel
metal, złoty | metal, golden | металл, золотой



antyczny róż 52 | antique pink 52

szary 14 | grey 14

brąz 48 | brown 48

jasny szary 03 | light grey 03

czarny 19 | black 19

cynamon 4215 | cinnamon 4215



beż 28 | beige 28

curry 68

turkusowy 85 | turquoise 85

granatowy 86 | dark blue 86

zielony 78 | green 78

Chic Velvet 88 | 43 | 50 | 49

tkanina aksamit: Bluvel | velvet fabric: Bluvel | ткань бархат: Bluvel
metal, czarny mat | metal, black mat | металл, черный матовый



zielony 78 | green 78

turkusowy 85 | turquoise 85

czarny 19 | black 19

granatowy 86 | dark blue 86

szary 14 | grey 14

beż 28 | beige 28

jasny szary 03 | light grey 03

curry 68

Chic D Velvet 88 | 43 | 50 | 49

tkanina aksamit: Bluvel | velvet fabric: Bluvel | ткань бархат: Bluvel
metal, dąb | metal, oak | металл, дуб



czarny 19 | black 19

szary 14 | grey 14

szary 85 | grey 85

czarny 99 | black 99

granatowy 79 | dark blue 79

Chic Chrom Velvet 88 | 43 | 50 | 49

tkanina aksamit: Bluvel | velvet fabric: Bluvel | ткань бархат: Bluvel
metal, chrom | metal, chrome | металл, хром

Chic Matt Velvet 88 | 43 | 50 | 49

tkanina aksamit: Matt Velvet | velvet fabric: Matt Velvet | ткань бархат: Matt Velvet
metal, czarny mat | metal, black mat | металл, черный матовый



czarny 19 | black 19

beż 28 | beige 28

jasny szary 03 | light grey 03

szary 14 | grey 14

curry 68

Cherry II Velvet 88 | 43 | 53 | 50

tkanina aksamit: Bluvel | velvet fabric: Bluvel | ткань бархат: Bluvel
metal, czarny mat | metal, black mat | металл, черный матовый



szary 14 | grey 14

oliwka 77 | olive 77

czarny 19 | black 19

jasny szary 03 | light grey 03

beż 28 | beige 28

Kayla Velvet 84 | 46 | 48 | 51

tkanina aksamit: Bluvel | velvet fabric: Bluvel | ткань бархат: Bluvel
metal, czarny mat | metal, black mat | металл, черный матовый



szary 14 | grey 14

jasny szary 03 | light grey 03

ciemny beż 40 | dark beige 40

oliwka 77 | olive 77

Praga Velvet 84 | 43 | 49 | 48

tkanina aksamit: Bluvel | velvet fabric: Bluvel | ткань бархат: Bluvel
metal, czarny mat | metal, black mat | металл, черный матовый



beż 28 | beige 28

szary 14 | grey 14

czarny 19 | black 19

jasny szary 03 | light grey 03

cinamon 4215 | cinnamon 4215

Jill Velvet 85 | 44 | 48 | 50

tkanina aksamit: Bluvel | velvet fabric: Bluvel | ткань бархат: Bluvel
metal, czarny mat+chrom | metal, black mat+chrome | металл, черный матовый+хром



zielony 79 | green 79

curry 66

krem 23 | cream 23

zielony 79 | green 79

Praga Szuks 84 | 43 | 49 | 48

tkanina szuiks: Fjord | corduroy fabric: Fjord | ткань вельвет: Fjord
metal, czarny mat | metal, black mat | металл, черный матовый

Monte Szuks 87 | 46 | 59 | 50

tkanina szuiks: Fjord | corduroy fabric: Fjord | ткань вельвет: Fjord
metal, czarny mat | metal, black mat | металл, черный матовый



ciemny beż 40 | dark beige 40

jasny szary 03 | light grey 03

szary 14 | grey 14

oliwka 77 | olive 77

Cobe Velvet 85 | 43 | 49 | 49

tkanina aksamit: Bluvel | velvet fabric: Bluvel | ткань бархат: Bluvel
metal, czarny mat | metal, black mat | металл, черный матовый



szary 14 | grey 14

czarny 19 | black 19

zielony 78 | green 78

beż 28 | beige 28

Colin B Velvet 82 | 45 | 52 | 48

tkanina aksamit: Bluvel | velvet fabric: Bluvel | ткань бархат: Bluvel
metal, czarny mat | metal, black mat | металл, черный матовый



szary 11 | grey 11

curry 66

ciemny beż 35 | dark beige 35

Kevin Vardo 79 | 44 | 57 | 49

tkanina Vardo | fabric Vardo | ткань Vardo
metal, czarny mat | metal, black mat | металл, черный матовый



jasny szary 03 | light grey 03 szary 14 | grey 14 brąz 48 | brown 48 curry 68 cynamon 4215 | cinnamon 4215



curry 68 granatowy 86 | dark blue 86 czarny 19 | black 19 jasny szary 03 | light grey 03 zielony 78 | green 78 szary 14 | grey 14 cynamon 4215 | cinnamon 4215

Piano Velvet 93 | 44 | 47 | 50

tkanina aksamit: Bluvel | velvet fabric: Bluvel | ткань бархат: Bluvel metal, czarny mat+zloty | metal, black mat+golden | металл, черный матовый+золотой



zielony 78 | green 78 beż 28 | beige 28 turkusowy 85 | turquoise 85 granatowy 86 | dark blue 86 czarny 19 | black 19

Mila Velvet 86 | 41 | 45 | 49

tkanina aksamit: Bluvel | velvet fabric: Bluvel | ткань бархат: Bluvel metal, czarny mat | metal, black mat | металл, черный матовый



zielony 78 | green 78 szary 14 | grey 14 czarny 19 | black 19 beż 28 | beige 28 granatowy 86 | dark blue 86

Piano B Velvet 93 | 44 | 47 | 50

tkanina aksamit: Bluvel | velvet fabric: Bluvel | ткань бархат: Bluvel metal, czarny mat | metal, black mat | металл, черный матовый



czarny 99 | black 99 szary 85 | grey 85 szary 14 | grey 14 beż 28 | beige 28 turkus 85 | turquoise 85

Mila Matt Velvet 86 | 41 | 45 | 49

tkanina aksamit: Matt Velvet | velvet fabric: Matt Velvet | ткань бархат: Matt Velvet metal, czarny mat | metal, black mat | металл, черный матовый

Mila D Velvet 86 | 41 | 45 | 49

tkanina aksamit: Bluvel | velvet fabric: Bluvel | ткань бархат: Bluvel metal, dqb | metal, oak | металл, дуб



szary 14 | grey 14 czarny 19 | black 19 szary 85 | grey 85 czarny 99 | black 99

Trix Velvet 89 | 47 | 49 | 48

tkanina aksamit: Bluvel | velvet fabric: Bluvel | ткань бархат: Bluvel metal, Bluvel | metal, Bluvel | металл, Bluvel

Piano B Matt Velvet 93 | 44 | 47 | 50

tkanina aksamit: Matt Velvet | velvet fabric: Matt Velvet | ткань бархат: Matt Velvet metal, czarny mat | metal, black mat | металл, черный матовый



beż 28 | beige 28 cynamon 4215 | cinnamon 4215 czarny 19 | black 19 szary 14 | grey 14 turkusowy 85 | turquoise 85

Lotus Velvet 91 | 45 | 52 | 51

tkanina aksamit: Bluvel | velvet fabric: Bluvel | ткань бархат: Bluvel metal, czarny mat | metal, black mat | металл, черный матовый



zielony 78 | green 78 beż 28 | beige 28 granatowy 86 | dark blue 86 szary 14 | grey 14 curry 68 czarny 19 | black 19

Trix B Velvet 89 | 47 | 49 | 48

tkanina aksamit: Bluvel | velvet fabric: Bluvel | ткань бархат: Bluvel metal, czarny mat | metal, black mat | металл, черный матовый





Twist Nea 89 | 41 | 42 | 49 | N

tkanina Nea | fabric Nea | ткань Nea
metal, czarny mat | metal, black mat | металл, черный матовый



Rip Brego 92 | 38 | 44 | 48 | N

tkanina: Brego | fabric: Brego | ткань: Brego
metal, czarny mat | metal, black mat | металл, черный матовый



Fox Velvet 89 | 40 | 43 | 48

tkanina aksamit | velvet fabric | ткань бархат
metal, czarny mat | metal, black mat | металл, черный матовый



Rip Velvet 92 | 38 | 44 | 48

tkanina aksamit: Bluvel | velvet fabric: Bluvel | ткань бархат: Bluvel
metal, czarny mat | metal, black mat | металл, черный матовый



Fox 89 | 40 | 43 | 48

tkanina | fabric | ткань
metal, dąb | metal, oak | металл, дуб

Fox 89 | 40 | 43 | 48

tkanina | fabric | ткань
metal, czarny mat / biały | metal, black mat / white | металл, черный матовый / белый



Atom Velvet 93 | 39 | 44 | 47

tkanina aksamit: Bluvel | velvet fabric: Bluvel | ткань бархат: Bluvel
metal, czarny mat | metal, black mat | металл, черный матовый



Irys Velvet 84 | 42 | 46 | 49

tkanina aksamit: Bluvel | velvet fabric: Bluvel | ткань бархат: Bluvel
metal, czarny mat | metal, black mat | металл, черный матовый



Vigo Velvet 97 | 38 | 44 | 48

tkanina aksamit: Bluvel | velvet fabric: Bluvel | ткань бархат: Bluvel
metal, czarny mat | metal, black mat | металл, черный матовый



April Vardo



curry 66

SPRĘŻYNY | POCKET SPRINGS

szary 11 | grey 11

grafit 19 | graphite 19

beż 34 | beige 34

April Vardo 94 | 45 | 42 | 49 N

tkanina: Vardo | fabric: Vardo | ткань: Vardo
metal, czarny mat | metal, black mat | металл, черный матовый



curry 68

SPRĘŻYNY | POCKET SPRINGS

ciemny szary 18 | dark grey 18

oliwka 77 | olive 77

beż 34 | beige 34

Berry Brego 97 | 44 | 44 | 50 N

tkanina: Brego | fabric: Brego | ткань: Brego
metal, czarny mat | metal, black mat | металл, черный матовый



Berry



Berry



szary 07 | grey 07

ciemny szary 18 | dark grey 18

oliwka 77 | olive 77

beż 34 | beige 34

Axo Brego 101 | 47 | 43 | 49

tkanina: Brego | fabric: Brego | ткань: Brego
metal, czarny mat | metal, black mat | металл, черный матовый



szary 14 | grey 14

czarny 19 | black 19

beż 28 | beige 28

Axo Velvet 101 | 47 | 43 | 49

tkanina aksamit: Bluvet | velvet fabric: Bluvet | ткань бархат: Bluvet
metal, czarny mat | metal, black mat | металл, черный матовый



szary, tap. 97 | grey, up. 97



beż, tap. 98 | beige, up. 98



szary | grey



czarny/biały | black/white

H-441 material

tkanina | fabric | ткань
metal, chrom | metal, chrome | металл, хром

H-200

ekoskóra | ecoleather | экокожа
metal, chrom | metal, chrome | металл, хром

H-441

ekoskóra | ecoleather | экокожа
metal, chrom | metal, chrome | металл, хром



czarny | black



biały | white



zielony 78 | green 78



jasny szary 03 | light grey 03



cynamon 4215 | cinnamon 4215



c. beż 40 | d. beige 40

H-090

ekoskóra | ecoleather | экокожа
metal, chrom | metal, chrome | металл, хром

H-090 Velvet

tkanina aksamit: Bluelvel | velvet fabric: Bluelvel | ткань бархат: Bluelvel
metal, black | metal, black | металл, чёрный



H-441 Velvet

tkanina aksamit | velvet fabric | ткань бархат
metal, black | metal, black | металл, чёрный



szary, tap. 93 | grey, up. 93



beż, tap. 191 | beige, up. 191



czarny, tap. 117 | black, up. 117



oliwka 10 | olive 10

Lou

skóra syntetyczna Buffalo | synthetic leather Buffalo | искусственная кожа Buffalo
metal, czarny mat | metal, black mat | металл, чёрный матовый



granatowy 86 | dark blue 86



zielony 78 | green 78

Texo Velvet

tkanina aksamit: Bluelvel | velvet fabric: Bluelvel | ткань бархат: Bluelvel
metal, czarny mat | metal, black mat | металл, чёрный матовый



c. beż | d. beige



szary | grey



czarny | black



krem | cream

H-261 chrom

ekoskóra | ecoleather | экокожа
metal, chrom | metal, chrome | металл, хром



krem | cream

H-261 bis k

ekoskóra | ecoleather | экокожа
metal, krem | metal, cream | металл, кремовый



brąz | brown



szary | grey



czarny | black



c. beż | d. beige

H-261 bis alu

ekoskóra | ecoleather | экокожа
metal, chrom | metal, chrome | металл, хром



szary 14 | grey 14

H-261 Velvet

tkanina aksamit: Bluelvel | velvet fabric: Bluelvel | ткань бархат: Bluelvel
metal, chrom | metal, chrome | металл, хром



szary | grey



czarny | black

H-260

ekoskóra | ecoleather | экокожа
metal, chrom | metal, chrome | металл, хром



szary 06 | grey 06



szary 06 | grey 06

H-733 Gandar

tkanina Gandar | Gandar fabric | Gandar ткань
metal, aluminium, czarny | metal, aluminium, black | металл, алюминий, чёрный





czarny | black



szary | grey



biały | white



jasny szary | light grey

Kris dąb

tworzywo PP+ekoskóra | plastic+eco leather | ПП пластик+экокожа
drewno dębowe | oak wood | натуральный дуб



biały | white



biały | white



szary, tap. 40 | grey, up. 40



Mosso

MDF | MDF | МДФ
drewno, dąb | wood, oak | древесина, дуб

Tibi

MDF | MDF | МДФ
drewno, dąb bielony | wood, white wash oak | белый дуб

CD-61

tkanina | fabric | ткань
drewno, dąb | wood, oak | древесина, дуб



szary | grey



jasny szary | light grey



czarny | black



biały | white

Kris buk

tworzywo PP+ekoskóra | plastic+eco leather | ПП пластик+экокожа
drewno bukowe | beech wood | бук



szary, tap. 40 | grey, up. 40



szary, tap. 130 | grey, up. 130



szary, tap. 130 | grey, up. 130



Karl

tkanina | fabric | ткань
drewno, dąb | wood, oak | древесина, дуб

Nelson

tkanina | fabric | ткань
drewno, dąb miodowy | wood, honey oak | древесина, медовый дуб

Brando

tkanina | fabric | ткань
drewno, dąb | wood, oak | древесина, дуб



biały | white



Ego

tworzywo PP | plastic | ПП пластик
metal, dąb | metal, oak | металл, дуб



czarny | black



jasny szary | light grey



biały | white

Moris

tworzywo PP | plastic | ПП пластик
drewno bukowe | beech wood | бук



czarny | black



c. orzech | d. walnut



biały | white



natural



niebieski | blue



biały | white



biały | white

Smart II

drewno | wood | древесина

CD-56

drewno | wood | древесина

CD-57

drewno | wood | древесина



ciemny szary 18 | dark grey 18



beż 34 | beige 34



oliwka 77 | olive 77

Ken Brego

tkanina Brego | fabric Brego | ткань Brego
metal, czarny mat | metal, black mat | металл, черный матовый



tap. 132 | up. 132



tap. 46 | up. 46



tap. 19 | up. 19



tap. 01 | up. 01

MN-SC

tkanina | fabric | ткань
drewno, biały, ciemny orzech | wood, white, dark walnut | древесина, белый, темный орех



tap. 08 | up. 08

OP-SC 2

tkanina | fabric | ткань
drewno, esgi | wood, esgi | древесина, эсрю



czarny, tap. 186 | black, up. 186



szary, tap. 195 | grey, up. 195

Prince 100 | 44 | 46 | 50

tkanina aksamit | velvet fabric | ткань бархат
stal nierdzewna, chrom | stainless steel, chrome | нержавеющей сталь, хром



czarny 19 | black 19



beż 28 | beige 28

Queen Velvet 111 | 46 | 53 | 49

tkanina aksamit: Bluvel | velvet fabric: Bluvel | ткань бархат: Bluvel
stal nierdzewna, złoty | stainless steel, golden | нержавеющей сталь, золотой



czarny 19 | black 19



beż 28 | beige 28

King Velvet 95 | 43 | 47 | 48

tkanina aksamit: Bluvel | velvet fabric: Bluvel | ткань бархат: Bluvel
stal nierdzewna, złoty | stainless steel, golden | нержавеющей сталь, золотой



czarny 19 | black 19



szary 14 | grey 14



zielony 78 | green 78



beż 28 | beige 28

August Velvet 98 | 46 | 56 | 51

tkanina aksamit: Bluvel | velvet fabric: Bluvel | ткань бархат: Bluvel
drewno, czarny | wood, black | древесина, черный



Prince



beż 28 | beige 28 szary 14 | grey 14 czarny 19 | black 19



szary 14 | grey 14 czarny 19 | black 19



beż 28 | beige 28 czarny 19 | black 19 szary 14 | grey 14



szary 14 | grey 14 czarny 19 | black 19

Cherry H-2 Velvet

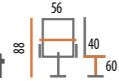

tkanina aksamit: Bluvel | velvet fabric: Bluvel | ткань бархат: Bluvel
metal, czarny mat | metal, black mat | металл, черный матовый

Cherry H-1 Velvet

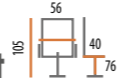

tkanina aksamit: Bluvel | velvet fabric: Bluvel | ткань бархат: Bluvel
metal, czarny mat | metal, black mat | металл, черный матовый

Mila H-2 Velvet

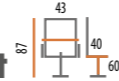

tkanina aksamit: Bluvel | velvet fabric: Bluvel | ткань бархат: Bluvel
metal, czarny mat | metal, black mat | металл, черный матовый

Colin B H-2 Velvet

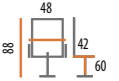

tkanina aksamit: Bluvel | velvet fabric: Bluvel | ткань бархат: Bluvel
metal, czarny mat | metal, black mat | металл, черный матовый



czarny 19 | black 19

szary 14 | grey 14

zielony 78 | green 78

szary 14 | grey 14

curry 68

beż 28 | beige 28

czarny 19 | black 19

Chic H-1 Velvet

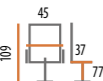

tkanina aksamit: Bluvel | velvet fabric: Bluvel | ткань бархат: Bluvel
metal, czarny mat | metal, black mat | металл, черный матовый

Chic H-2 Velvet

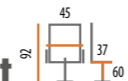

tkanina aksamit: Bluvel | velvet fabric: Bluvel | ткань бархат: Bluvel
metal, czarny mat | metal, black mat | металл, черный матовый



szary 14 | grey 14

zielony 78 | green 78

czarny 19 | black 19

beż 40 | beige 40

C-105 Velvet

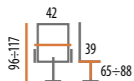

tkanina aksamit: Bluvel | velvet fabric: Bluvel | ткань бархат: Bluvel
metal, czarny mat | metal, black mat | металл, черный матовый



czarny 19 | black 19

C-617



ekoskóra | eco leather | экокожа
metal, chrom | metal, chrome | металл, хром



Sting

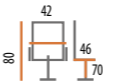

tworzywo PP | plastic | ПП пластик
metal, dąb | metal, oak | металл, дуб



CD-964

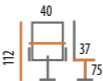

drewno, biały | wood, white | древесина, белый



Metro H-1



okleina nat. / drewno dębowe | natural veneer / oak wood | нат. шпон / дуба
metal, czarny mat | metal, black mat | металл, черный матовый



Maryland 110-119 57 49 44-53

ekoskóra, kolor: czarny / orzech, mechanizm TILT
eco leather, color: black / walnut, TILT mechanism
экокожа, цвет: черный / орех, механизм Тилт



Alabama 113-121 66 47 48-56 N

ekoskóra, kolor: czarny / orzech, mechanizm TILT
eco leather, color: black / walnut, TILT mechanism
экокожа, цвет: черный / орех, механизм Тилт



Oregon 96-108 67 43 44-54

ekoskóra, kolor: czarny / orzech, mechanizm TILT
eco leather, color: black / walnut, TILT mechanism
экокожа, цвет: черный / орех, механизм Тилт



Vermont 91-103 64 45 48-60 N

ekoskóra, kolor: czarny / orzech, mechanizm TILT
eco leather, color: black / walnut, TILT mechanism
экокожа, цвет: черный / орех, механизм Тилт



Arizona Velvet 94-105 55 44 46-56

tkanina aksamit, kolor: szary, tap. 181 / orzech, mechanizm TILT
velvet fabric, color: grey, up. 181 / walnut, TILT mechanism
ткань бархат, цвет: серый, об. 181 / орех, механизм Тилт



Kansas 117-129 62 44 48-60 N

ekoskóra, kolor: czarny / orzech, mechanizm TILT
eco leather, color: black / walnut, TILT mechanism
экокожа, цвет: черный / орех, механизм Тилт



Q-087 115-125 66 50 46-56

ekoskóra, kolory: czarny, biały, szary, mechanizm TILT
eco leather, colors: black, white, grey, TILT mechanism
экокожа, цвет: черный, белый, серый, механизм Тилт

Q-087 material 115-125 66 50 46-56

tkanina, kolor: szary, mechanizm TILT
fabric, color: grey, TILT mechanism
ткань, цвет: серый, механизм Тилт



Q-904 114-124 65 51 48-58 N

skóra syntetyczna, kolor: ciemny beż, brąz, czarny, mechanizm TILT
synthetic leather, color: dark beige, brown, black, TILT mechanism
искусственная кожа, цвет: темный бежевый, коричневый, черный, механизм Тилт

Q-557 118-126 64 55 47-54

ekoskóra, kolor: brąz, mechanizm TILT
eco leather, color: brown, TILT mechanism
экокожа, цвет: коричневый, механизм Тилт



Q-154 116-122 65 53 51-57

ekoskóra, kolor: czarny, multiblock
eco leather, color: black, multiblock
экокожа, цвет: черный, мультиблок

Q-154 116-122 65 53 51-57

skóra naturalna, kolor: czarny, multiblock
natural leather, color: black, multiblock
натуральная кожа, цвет: черный, мультиблок



Q-278 106-115 68 50 44-53

tkanina, kolor: brąz, mechanizm TILT
fabric, color: brown, TILT mechanism
ткань, цвет: коричневый, механизм Тилт



Q-306 106-116 58 51 47-57

skóra syntetyczna, kolory: szary, czarny, brąz, mechanizm TILT
synthetic leather, colors: grey, black, brown, TILT mechanism
искусственная кожа, цвет: серый, черный, коричневый, механизм Тилт

Q-046 110-120 62 50 44-54

ekoskóra, kolor: szary, mechanizm TILT
eco leather, color: grey, TILT mechanism
экокожа, цвет: серый, механизм Тилт



Q-270 114-124 66 50 49-58

ekoskóra, kolor: czarny, mechanizm TILT
eco leather, color: black, TILT mechanism
экокожа, цвет: черный, механизм Тилт

Q-031 112-120 64 48 49-57

ekoskóra, kolory: szary, czarny, beż, mechanizm TILT
eco leather, colors: grey, black, beige, TILT mechanism
экокожа, цвет: серый, черный, бежевый, механизм Тилт



Q-052 113-126 66 48 46-57

ekoskóra, kolor: czarny, mechanizm TILT
eco leather, color: black, TILT mechanism
экокожа, цвет: черный, механизм Тилт

Q-036 117-127 61 53 45-55

ekoskóra, kolor: czarny, mechanizm TILT
eco leather, color: black, TILT mechanism
экокожа, цвет: черный, механизм Тилт

Consul 112-120 70 57 46-54

ekoskóra / tkanina membr., kolor: czarny, mechanizm TILT
eco leather / fabric membrane, color: black, TILT mechanism
экокожа / мембр. ткань, цвет: черный, механизм Тилт



Devon 119-129 68 50 44-54 N

fotel ergonomiczny, siatka, kolory: czarny, szary, multiblock, reg. podłokietniki 4D / odcinek lędźwiowy / zagłówek
 ergonomic chair, mesh, colors: black, grey, multiblock, adjustable armrests 4D / lumbar region / headrest
 эргономичный стул, сетка, цвет: черный, серый, мультиблок, рег. подлокотники / поясничная область / подголовник



Q-095 117-126 60 50 46-55

siatka / tkanina membranowa, kolor: czarny, czarny / szary, mechanizm TILT
 mesh / fabric membrane, color: black, black / grey, TILT mechanism
 сетка / ткань мембранная, цвет: черный, черный / серый, механизм Тилт



Q-058 119-123 65 50 46-56 N

siatka / tkanina membranowa, kolor: czarny, multiblock, reg. podłokietniki / odcinek lędźwiowy / zagłówek
 mesh / fabric membrane, color: black, multiblock, adj. armrests / lumbar region / headrest
 мемб. ткань / сетка, цвет: черный, multiblock, рег. подлокотники / поясничная область / подголовник



Ergon 113-122 64 49-54 46-56

fotel ergonomiczny, skóra syntetyczna / siatka / tkanina, kolory: czarny, szary, multiblock, reg. podłokietniki 4D / głębokość siedziska / odcinek lędźwiowy / zagłówek
 ergonomic chair, synthetic leather / mesh / fabric, colors: black, grey, multiblock, adjustable armrests 4D / seat depth / lumbar region / headrest
 эргономичный стул, искусственная кожа / сетка / ткань, цвет: черный, серый, мультиблок, рег. подлокотники / глубина сиденья / поясничная область / подголовник



Q-118 115-125 65 44 47-57

siatka / tkanina membranowa, kolor: czarny, szary, multiblock, reg. zagłówek / wys. oparcia
 mesh / fabric membrane, color: black, grey, multiblock, adjustable headrest / backrest height
 сетка / ткань мембранная, цвет: черный, серый, мультиблок, рег. подголовник / высота спинки



Q-406 102-110 67 52 46-54

siatka / ekoskóra, kolor: czarny, mechanizm TILT, reg. podłokietniki / zagłówek / odcinek lędźwiowy
 mesh / eco leather, color: black, TILT mechanism, adjustable armrests / headrest / lumbar region
 сетка / экокожа, цвет: черный, механизм Тилт, рег. подлокотники / подголовник / поясничная область



Q-060 118-126 66 50 45-53

siatka / tkanina, kolor: czarny, mechanizm TILT, reg. podłokietniki / odc. lędźwiowy / zagłówek
 mesh / fabric, color: black, TILT mechanism, adjustable armrests / lumbar region / headrest
 сетка / ткань, цвет: черный, механизм Тилт, рег. подлокотники / поясничная об. / рег. подголовник



Q-639 113-126 64 43 48-58

siatka / tkanina membranowa, kolor: szary, mechanizm TILT, reg. podłokietniki / zagłówek
 mesh / fabric membrane, color: grey, TILT mechanism, adjustable armrests / headrest
 ткань мемб.+сетка, цвет: серый, механизм Тилт, рег. подлокотники / подголовник



Q-118 R 115-125 65 44 47-57 N

siatka / tkanina membranowa, kolor: czarny, szary, multiblock, reg. podłokietniki / zagłówek / wys. oparcia
 mesh / fabric membrane, color: black, grey, multiblock, adjustable armrests / headrest / backrest height
 сетка / ткань мембранная, цвет: черный, серый, мультиблок, рег. подлокотники / подголовник / высота спинки



Q-409 117-127 63 51 45-55

siatka / tkanina, kolor: czarny, mechanizm TILT
 mesh / fabric, color: black, TILT mechanism
 сетка / ткань, цвет: черный, механизм Тилт



Q-346 63
106-117 46
44-55

siatka / skóra syntetyczna, kolory: szary, czarny, mechanizm TILT
mesh / synthetic leather, colors: grey, black, TILT mechanism
сетка / искусственная кожа, цвет: серый, черный, механизм Тилт



Q-035 59
121-131 52
46-56

ekoskóra, kolor: biały / tkanina, kolor: szary, mechanizm TILT
eco leather, color: white / fabric, color: grey, TILT mechanism
экокожа, цвет: белый / ткань, цвет: серый, механизм Тилт



Q-136 70
119-129 49
46-56

tkanina, kolor: szary, mechanizm TILT
fabric, color: grey, TILT mechanism
ткань, цвет: серый, механизм Тилт



Q-026 59
107-117 48
44-54

skóra syntetyczna / siatka / tkanina membranowa, kolory: szary, różowy / biały, mechanizm TILT
synthetic leather / mesh / fabric membrane, colors: grey, pink / white, TILT mechanism
искусственная кожа / сетка / ткань мембранная, цвет: серый, розовый / белый, механизм Тилт



REGULOWANE PODŁOKIETNIKI

Q-861 66
113-123 50
44-54

siatka / tkanina, kolor: czarny, szary, mechanizm TILT, reg. podłokietniki
mesh / fabric, color: black, grey, TILT mechanism, adj. armrests
сетка / ткань, цвет: черный, серый, механизм Тилт, рег. подлокотники



Q-336 65
117-127 50
47-57

siatka / tkanina, kolor: czarny, szary, mechanizm TILT
mesh / fabric, color: black, grey, TILT mechanism
сетка / ткань, цвет: черный, серый, механизм Тилт



Q-025 62
110-116 50
45-54

siatka / tkanina membranowa, kolory: czarny, zielony, szary / czarny, mechanizm TILT
mesh / fabric membrane, colors: black, green, grey / black, TILT mechanism
сетка / мембранная ткань, цвет: черный, зеленый, серый / черный, механизм Тилт



Q-025 material 62
110-116 50
45-54

siatka / tkanina, kolory: czarny, szary / czarny, mechanizm TILT
mesh / fabric, colors: black, grey / black, TILT mechanism
сетка / ткань, цвет: черный, серый / черный, механизм Тилт



Q-345 62
118-128 49
47-57

siatka / tkanina, kolor: czarny, szary, mechanizm TILT
mesh / fabric, color: black, grey, TILT mechanism
сетка / ткань, цвет: черный, серый, механизм Тилт



Q-211 69
115-124 46
40-49

siatka / tkanina membranowa, kolor: czarny, TILT, reg. podłokietniki
mesh / fabric membrane, color: black, TILT, adj. armrests
мемб. ткань / сетка, цвет: черный, Тилт, рег. подлокотники



REGULOWANE PODŁOKIETNIKI



Q-319 64
112-122 52
48-58

tkanina, kolory: czarny, szary, mechanizm TILT
fabric, colors: black, grey, TILT mechanism
ткань, цвет: черный, серый, механизм Тилт



Q-078 58
92-102 46
46-56

siatka / tkanina membranowa, kolor: czarny, mechanizm TILT
mesh / fabric membrane, color: black, TILT mechanism
сетка / мембранная ткань, цвет: черный, механизм Тилт





Q-330 103-113 62 48 47-57

siatka / tkanina, kolory: czarny / szary, czarny / czarny, czarny / żółty, mechanizm TILT
 mesh / fabric, colors: black / grey, black / black, black / yellow, TILT mechanism
 сетка / ткань, цвет: черный / серый, черный / черный, черный / желтый, механизм Тилт



Q-328H 97-117 62 48 44-54

siatka / tkanina, kolory: czarny / czarny, czarny / szary, czarny / niebieski, multiblock, reg. zagłówek
 mesh / fabric, colors: black / black, black / grey, black / blue, multiblock, adjustable headrest
 сетка / ткань, цвет: черный / черный, черный / серый, черный / синий, мультиблок, рег. подголовник

NOWY KOLOR



Q-330 R 103-113 62 48 47-57 N

siatka / tkanina, kolory: czarny / szary, czarny / czarny, mechanizm TILT, reg. podłokietniki
 mesh / fabric, colors: black / grey, black / black, TILT mechanism, adjustable armrests
 сетка / ткань, цвет: черный / серый, черный / черный, механизм Тилт, рег. подлокотники

REGULOWANE PODŁOKIETNIKI

REGULOWANE PODŁOKIETNIKI

Q-320 R 97-108 60 44 44-54 N

siatka / tkanina, kolory: czarny / szary, siatka / tkanina membranowa, kolor: czarny, mechanizm TILT, reg. podłokietniki
 mesh / fabric, colors: black / grey, mesh / fabric membrane, colors: black, TILT mechanism, adjustable armrests
 сетка / ткань, цвет: черный / серый; сетка / ткань мембранная, цвет: черный, механизм Тилт, рег. подлокотники



Q-328 97-107 62 48 44-54

siatka / tkanina, kolory: czarny / czarny, czarny / szary, czarny / niebieski, mechanizm TILT
 mesh / fabric, colors: black / black, black / grey, black / blue, TILT mechanism
 сетка / ткань, цвет: черный / черный, черный / серый, черный / синий, механизм Тилт

NOWY KOLOR



Q-320 97-108 60 44 44-54

siatka / tkanina, kolory: szary / czarny, siatka / tkanina membranowa, kolor: różowy, niebieski, mechanizm TILT
 mesh / fabric, colors: grey / black, mesh / fabric membrane, colors: pink, blue, TILT mechanism
 сетка / ткань, цвет: серый / черный, сетка / ткань мембранная, цвет: розовый, синий, механизм Тилт



Q-333 100-110 65 47 44-54

siatka / tkanina, kolory: szary / pomarańczowy, szary / szary, czarny / czarny, szary / niebieski, mechanizm TILT, reg. podłokietniki / odc. lędźwiowy
 mesh / fabric, colors: grey / orange, grey / grey, black / black, grey / blue, TILT mechanism, adjustable armrests / lumbar region
 сетка / ткань, цвет: серый / оранжевый, серый / серый, черный / черный, серый / синий, механизм Тилт, рег. подлокотники / поясничная об.

60°



Camaro 106-116 59 49 44-54

tkanina, kolory: czarny / czerwony, czarny / szary, czarny / niebieski, czarny / żółty, mechanizm TILT
 fabric, colors: black / red, black / grey, black / blue, black / yellow, TILT mechanism
 ткань, цвет: черный / красный, черный / серый, черный / синий, черный / желтый, механизм Тилт



Revolt 120-130 67 51 48-58

siatka / skóra syntetyczna, kolor: czarny / czerwony, multiblock, reg. podłokietniki 3D
 mesh / synthetic leather, color: black / red, multiblock, adjustable armrests 3D
 сетка / искусственная кожа, цвет: черный / красный, мультиблок, рег. подлокотники



Q-939 108-120 56 48 44-56

siatka / tkanina, kolor: czarny / szary, multiblock, podnóżek
 mesh / fabric, color: black / grey, multiblock, footrest
 сетка / ткань, цвет: черный / серый, мультиблок, подставка для ног



NOWY KOLOR



Viper 127-135 70 49 44-52

tkanina, kolory: czarny / czerwony, czarny / niebieski, czarny / żółty, czarny / szary, czarny, multiblock, reg. podłokietniki 3D
 fabric, colors: black / red, black / blue, black / yellow, black / grey, black, multiblock, adjustable armrests 3D
 ткань, цвет: черный / красный, черный / синий, черный / желтый, черный / серый, черный, мультиблок, рег. подлокотники 3D



Zenko 112-130 66 48 45-51

tkanina, kolor: czarny / szary, mechanizm TILT
 fabric, color: black / grey, TILT mechanism
 ткань, цвет: черный / серый, механизм Тилт

Dakar 106-114 63 48 43-51

tkanina, kolory: czarny / czerwony, czarny / niebieski, mechanizm TILT
 fabric, colors: black / red, black / grey, black / blue, black / yellow, TILT mechanism
 ткань, цвет: черный / красный, черный / серый, черный / синий, черный / желтый, механизм Тилт



Q-033 116-126 63 50 49-59

ekoskóra, kolor: czarny / tkanina membr., kolor: czarny, mechanizm TILT
 eco leather, color: black / fabric membrane, color: black, TILT mechanism
 экокожа, цвет: черный / мемб. ткань, цвет: черный, механизм Тилт

Rapid 108-119 65 47 46-56

tkanina, kolor: czarny / szary, mechanizm TILT
 fabric, color: black / grey, TILT mechanism
 ткань, цвет: черный / серый, механизм Тилт

Q-229 120-130 64 50 47-57

tkanina, kolor: czarny / szary, multiblock, reg. podłokietniki
 fabric, color: black / grey, multiblock adjustable armrests
 ткань, цвет: черный / серый, мультиблок, рег. подлокотники



Q-289 98=106 | 60 | 44 | 50-58

tkanina, kolor: szary, mechanizm TILT
fabric, color: grey, TILT mechanism
ткань, цвет: серый, механизм Тилт



Q-288 98=106 | 60 | 43 | 49-57

skóra syntetyczna, kolor: szary, mechanizm TILT
synthetic leather, color: grey, TILT mechanism
искусственная кожа, цвет: серый, механизм Тилт



Q-019 112=122 | 61 | 50 | 46-56

ekoskóra / tkanina membr., kolor: czarny, TILT
eco leather / fabric membrane, color: black, TILT
экокожа / мембр. ткань, цвет: черный, Тилт



Q-886 Velvet 83=91 | 58 | 44 | 47-55

tkanina aksamit: Bluvel, kolory: jasny szary 03, antyczny róż 52, ciemny beż 40, mechanizm TILT
velvet fabric: Bluvel, colors: light grey 03, antique rose 52, dark beige 40, TILT mechanism
ткань бархат: Bluvel, цвет: светлый серый 14, античный розовый 52, бежевый 40, механизм Тилт



NOWY KOLOR



Rose Velvet 74=83 | 56 | 41 | 48-57

tkanina aksamit: Bluvel, kolor: szary 14, antyczny róż 52
velvet fabric: Bluvel, color: grey 14, antique rose 52
ткань бархат: Bluvel, цвет: серый 14, античный розовый 52



Daisy 88=98 | 60 | 47 | 45-55

tworzywo / tkanina membr., kolory: szary, różowy, mechanizm TILT
plastic / fabric membrane, colors: grey, pink, TILT mechanism
пластик / мембр. ткань, цвет: серый, розовый, механизм Тилт



Q-190 Velvet 80=91 | 60 | 44 | 43-54

tkanina aksamit: Bluvel, kolory: szary 14, antyczny róż 52, ciemny beż 40, mechanizm TILT
velvet fabric: Bluvel, colors: grey 14, antique rose 52, dark beige 40, TILT mechanism
ткань бархат: Bluvel, цвет: серый 14, античный розовый 52, бежевый 40, механизм Тилт



NOWY KOLOR



Q-121 74=86 | 41 | 41 | 43-53

siatka / tkanina membranowa, kolor: czarny
mesh / fabric membrane, color: black
сетка / ткань мембранная, цвет: черный



Q-083 89=101 | 59 | 44 | 41-53

siatka / tkanina membranowa, kolor: czarny
mesh / fabric membrane, color: black
сетка / ткань мембранная, цвет: черный



Stopka

zestaw 5 szt. stopek do foteli obrotowych
set of 5 pieces of footers for office chairs
набор 5 резиновых ножек



Kółko

zestaw 5 szt. kółek kauczukowych do foteli obrotowych
set of 5 pieces of rubber wheels for office chairs
набор 5 резиновых колес

Siłownik

siłownik
gas lift
разлифт



Q-G2 80=92 | 48 | 41 | 38-50

tkanina membranowa, kolory: niebiesko-czarny, różowy, szaro-czarny, różowo-szary
fabric membrane, colors: blue-black, pink, grey-black, pink-grey
мембранная ткань, цвет: черно-синий, розовый, серый-черный, розовый-серый



Q-020 Velvet

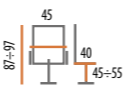

tkanina aksamit: Bluvel, kolory: czarny 19, zielony 78, granatowy 86, curry 68, bordowy 59, turkusowy 85, szary 14, antyczny róż 52
 velvet fabric: Bluvel, colors: black 19, green 78, dark blue 86, curry 68, claret 59, turquoise 85, grey 14, antique rose 52
 ткань бархат: Bluvel, цвет: черный 19, зеленый 78, темный синий 86, карри 68, бордовой 59, бирюзовый 85, серый 14, античный розовый 52



Q-022 Velvet

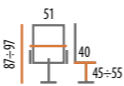

tkanina aksamit: Bluvel, kolory: szary 14, zielony 78, curry 68, turkusowy 85, antyczny róż 52
 velvet fabric: Bluvel, colors: grey 14, green 78, curry 68, turquoise 85, antique rose 52
 ткань бархат: Bluvel, цвет: серый 14, зеленый 78, карри 68, бирюзовый 85, античный розовый 52



Q-022

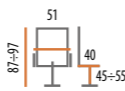

ekoskóra, kolory: czarny, różowy, szary, fioletowy, biały
 eco leather, colors: black, pink, grey, violet, white
 экокожа, цвет: черный, розовый, серый, фиолетовый, белый

Q-022 material

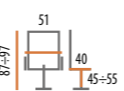

tkanina, kolor: szary
 fabric, color: grey
 ткань, цвет: серый



B-005



plyta laminowana, kolor: dąb wotan+antracyt
 laminated board, color: wotan oak+anthracite
 ламин. ДСП, цвет: дуб вотан+антрацит



B-021



blat: plyta laminowana, stelaż: metal, kolor: brąz rustykalny / czarny
 top: laminated board, frame: metal, color: rustic brown / black
 стол: ламин. ДСП, каркас: металл, цвет: рустикальный коричневый / черный



B-011



plyta laminowana, kolor: old wood / materia c. szary
 laminated board, color: old wood / materia d. grey
 ламин. ДСП, цвет: old wood / materia т. серый



B-011



plyta laminowana, kolor: antracyt / dąb artisan
 laminated board, color: anthracite / artisan oak
 ламин. ДСП, цвет: антрацит / дуб artisan



B-011



plyta laminowana, kolor: dąb artisan
 laminated board, color: artisan oak
 ламин. ДСП, цвет: дуб artisan



B-012



plyta laminowana, kolor: old wood / materia c. szary
 laminated board, color: old wood / materia d. grey
 ламин. ДСП, цвет: old wood / materia т. серый



B-012



plyta laminowana, kolor: dąb artisan / antracyt
 laminated board, color: artisan oak / anthracite
 ламин. ДСП, цвет: дуб artisan / антрацит



B-012



plyta laminowana, kolor: dąb artisan
 laminated board, color: artisan oak
 ламин. ДСП, цвет: дуб artisan



B-013

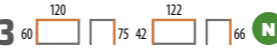

plyta laminowana, kolor: old wood / materia c. szary
 laminated board, color: old wood / materia d. grey
 ламин. ДСП, цвет: old wood / materia т. серый



B-013



plyta laminowana, kolor: antracyt / dąb artisan
 laminated board, color: anthracite / artisan oak
 ламин. ДСП, цвет: антрацит / дуб artisan



B-013



plyta laminowana, kolor: dąb artisan
 laminated board, color: artisan oak
 ламин. ДСП, цвет: дуб artisan

uniwersalne (lewe + prawe) | universal (left + right) | универсальная (левая + правая)

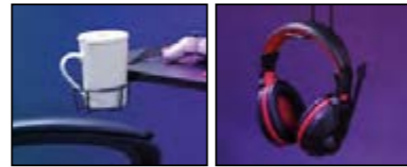

światła LED / LED lights / светодиод

B-219 120 60 76

blat: płyta laminowana, stelaż: metal, kolor: czarny
top: laminated board, frame: metal, color: black
стол: ламин. ДСП, каркас: металл, цвет: черный

B-202 120 60 76(88)

blat: płyta laminowana, stelaż: metal, kolor: czarny / czerwony
top: laminated board, frame: metal, color: black / red
столешница: ламин. ДСП, каркас: металл, цвет: черный / красный

B-216 120 60 76

blat: płyta laminowana, stelaż: metal, kolor: czarny
top: laminated board, frame: metal, color: black
стол: ламин. ДСП, каркас: металл, цвет: черный



6 szuflad / 6 drawers / 6 ящика

Geo K6 96 70 40



4 szuflady / 4 drawers / 4 ящика

Geo K4 74 70 40



1 szuflada / 1 drawer / 1 ящика

Geo S 59 40 40

Geo

płyta laminowana, stelaż: metal, kolor: dąb / czarny mat
laminated board, frame: metal, color: oak / black mat
ламин. ДСП, каркас: металл, цвет: дуб / черный матовый



B-233 60 48 73

blat: płyta+okleina, stelaż: metal, kolor: c. brąz / aluminium, dąb / czarny mat
top: board+veneer, frame: metal, color: d. brown / aluminium, oak / black mat
стол: ДСП+шпон, каркас: металл, цвет: т. коричневый / алюминий, дуб / черный матовый

B-07 74 55 95

blat: płyta+okleina, stelaż: metal, kolor: c. brąz / aluminium
top: board+veneer, frame: metal, color: d. brown / aluminium
стол: ДСП+шпон, каркас: металл, цвет: т. коричневый / алюминий

Tablo B 110 48 76

blat: płyta laminowana, stelaż: metal, kolor: dąb / c. brąz
top: laminated board, frame: metal, color: oak / d. brown
столешница: ламин. ДСП, каркас: металл, цвет: дуб / т. корич.



B-036 90 50 76(113)

blat: płyta laminowana, stelaż: metal, kolor: dąb / czarny mat
top: laminated board, frame: metal, color: oak / black mat
стол: ламин. ДСП, каркас: металл, цвет: дуб / черный матовый



B-027 95 48 76

blat: płyta laminowana, stelaż: metal, kolor: dąb / czarny mat
top: laminated board, frame: metal, color: oak / black mat
стол: ламин. ДСП, каркас: металл, цвет: дуб / черный матовый



B-168 77 48 89

blat: płyta laminowana, stelaż: metal, kolor: dąb / c. brąz
top: laminated board, frame: metal, color: oak / d. brown
столешница: ламин. ДСП, каркас: металл, цвет: дуб / т. кор.



Matis A 52 147 48

płyta laminowana, stelaż: metal, kolor: dąb / c. brąz
laminated board, frame: metal, color: oak / d. brown
ламин. ДСП, каркас: металл, цвет: дуб / т. корич.



Olsen A 65 154 40

płyta laminowana, stelaż: metal, kolor: dąb / biały
laminated board, frame: metal, color: oak / white
ламин. ДСП, каркас: металл, цвет: дуб / белый

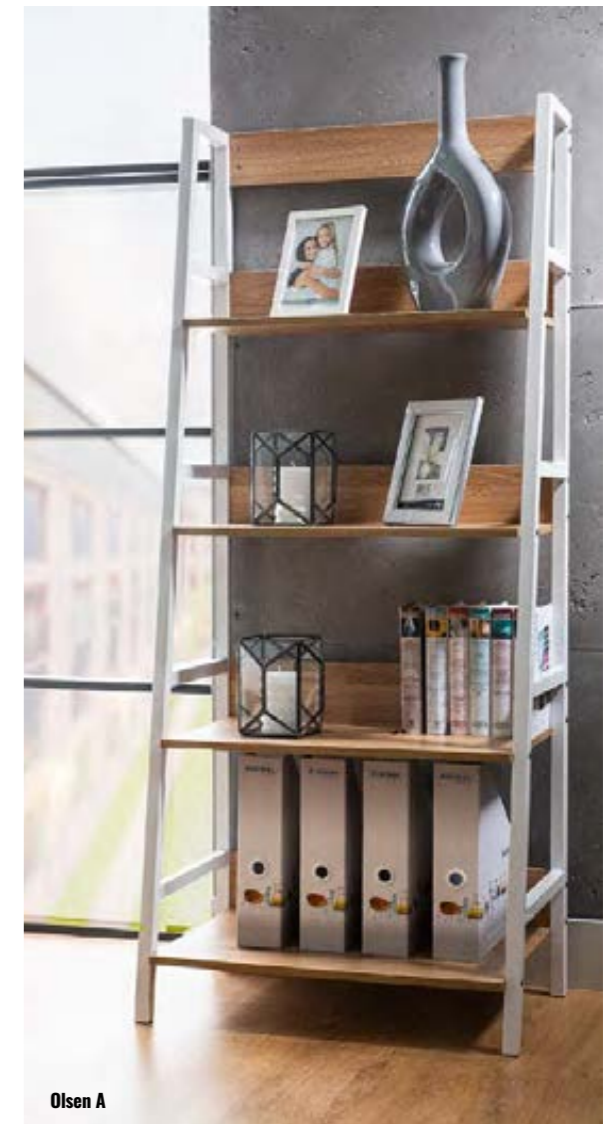

Olsen A



Tablo R5 180 60 40
regal / bookstand / книжная полка



Tablo R4 140 60 40
regal / bookstand / книжная полка



Tablo R3 99 60 40
regal / bookstand / книжная полка

Tablo

regal / bookstand / книжная полка
plyta laminowana, stelaż metal, kolor: dąb / c. brąz | laminated board, frame: metal, color: oak / d. brown | ламин. ДСП, каркас: металл, цвет: дуб / т. корич.



Loft R5 146 60 30 **N**

Loft R4 115 60 30 **N**

Loft N

regal / bookstand / книжная полка
plyta laminowana, stelaż metal, kolory: czarny, s. orzech / czarny mat | laminated board, frame: metal, colors: black, d. walnut / black mat | ламин. ДСП, каркас: металл, цвет: черный, т. орех / черный матовый



Net A 163 85 35 **N**

Net B 132 75 35 **N**

Net N

regal / bookstand / книжная полка
plyta laminowana, stelaż metal, kolory: czarny, s. orzech / czarny mat | laminated board, frame: metal, colors: black, d. walnut / black mat | ламин. ДСП, каркас: металл, цвет: черный, т. орех / черный матовый



Lex N **Lex A** **Lex B**

regal / bookstand / книжная полка
 płyta laminowana, stelaż metal, kolor: dąb / czarny mat | laminated board, frame: metal, color: oak / black mat
 ламин. ДСП, каркас: металл, цвет: дуб / черный матовый



Raw R4

NOWY KOLOR



Raw



Costa



Raw R5

NOWY KOLOR



Raw R6

NOWY KOLOR

Raw

regal / bookstand / книжная полка
 płyta laminowana, stelaż: metal, kolory: dąb, czarny / czarny mat | laminated board, frame: metal, colors: oak, black / black mat | ламин. ДСП, каркас: металл, цвет: дуб, черный / черный матовый



Costa A

NOWY KOLOR



Costa B

NOWY KOLOR

Costa

regal / bookstand / книжная полка
 płyta laminowana, stelaż: metal, kolory: dąb, czarny / czarny mat | laminated board, frame: metal, colors: oak, black / black mat | ламин. ДСП, каркас: металл, цвет: дуб, черный / черный матовый



Noel 155 45 25

regal / bookstand / книжная полка
 płyta laminowana, kolor: dąb wotan+czarny
 laminated board, color: wotan oak+black
 ламин. ДСП, цвет: дуб вотан+черный



Tipi 136 80 30

regal / bookstand / книжная полка
 płyta laminowana, kolor: dąb wotan+czarny
 laminated board, color: wotan oak+black
 ламин. ДСП, цвет: дуб вотан+черный



Corner 170 60 25

regal / bookstand / книжная полка
 płyta laminowana, kolory: dąb wotan+czarny, dąb wotan, antracyt
 laminated board, colors: wotan oak+black, wotan oak, antracithe
 ламин. ДСП, цвет: дуб вотан+черный, дуб вотан, антрацит



Corner



Tipi



Combo 165 80 29

regal / bookstand / книжная полка
 płyta laminowana, kolor: dąb wotan+antracyt
 laminated board, color: wotan oak+anthracithe
 ламин. ДСП, цвет: дуб вотан+антрацит



Matrix 170 100 25

regal / bookstand / книжная полка
 płyta laminowana, kolory: dąb wotan / antracyt
 laminated board, colors: wotan oak / anthracithe
 ламин. ДСП, цвет: дуб вотан / антрацит



Tiki 165 35 35

regal / bookstand / книжная полка
 płyta laminowana, kolor: dąb wotan, dąb wotan / antracyt
 laminated board, color: wotan oak, wotan oak / anthracithe
 ламин. ДСП, цвет: дуб вотан, дуб вотан / антрацит



Noel



Tiki



P-006 29 145 184

zestaw, płyta laminowana, kolory: dąb artisan+biały mat
set, laminated board, color: artisan oak+white mat
набор, ламин. ДСП, цвет: дуб artisan+белый матовый



P-007 30 150 190

zestaw, płyta laminowana, kolory: dąb artisan / antracyt
set, laminated board, color: artisan oak / anthracite
набор, ламин. ДСП, цвет: дуб artisan / антрацит



P-013 40 100 204

zestaw, płyta laminowana, kolory: dąb evoke / grafit, biały
set, laminated board, color: evoke oak / graphite, white
набор, ламин. ДСП, цвет: дуб evoke / графит, белый



Ava A 84 169 40

regal / bookstand / книжная полка

Ava B 52 169 40

regal / bookstand / книжная полка

Ava N

regal / bookstand / книжная полка
płyta laminowana, stelaż metal, kolor: orzech / czarny mat | laminated board, frame: metal, color: walnut / black mat | ламин. ДСП, каркас: металл, цвет: орех / черный матовый



Rin A 80 200 40

regal / bookstand / книжная полка

Rin B 80 200 40

regal / bookstand / книжная полка

Rin C 80 200 40

regal / bookstand / книжная полка

Rin N

płyta laminowana, stelaż metal, kolor: czarny / czarny mat
laminated board, frame: metal, color: black / black mat
ламин. ДСП, каркас: металл, цвет: черный / черный матовый



Nova

czarny / chrom
black / chrome
черный / хром



Nova II

czarny / chrom
black / chrome
черный / хром



Nova II Bis

czarny / chrom
black / chrome
черный / хром



Lugo

metal+drewno, kolor: czarny+buk
metal+wood, color: black+beech
металл+древесина, цвет: черный+бук



Santos

metal, kolor: czarny+zloty
metal, color: black+golden
металл, цвет: черный+золотой



Albin

metal+drewno, kolor: czarny+buk
metal+wood, color: black+beech
металл+древесина, цвет: черный+бук



Foster

metal+drewno, kolor: czarny+buk
metal+wood, color: black+beech
металл+древесина, цвет: черный+бук



Greg

biały, wenge / chrom
white, wenge / chrome
белый, венге / хром

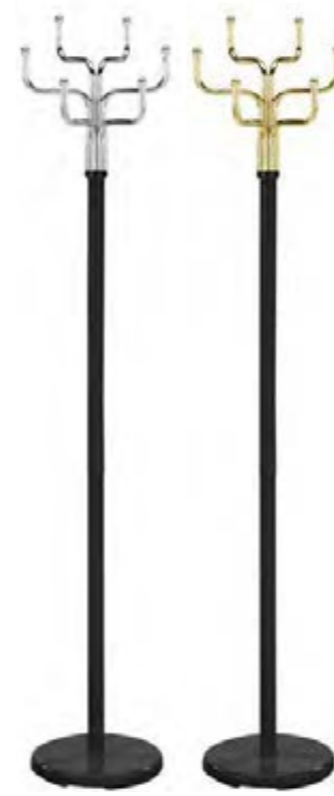

Cosmic

metal, kolor: czarny+chrom, czarny+zloty
metal, color: black+chrome, black+golden
металл, цвет: черный+хром, черный+золотой



Vivian

metal+drewno, kolor: czarny+buk
metal+wood, color: black+beech
металл+древесина, цвет: черный+бук

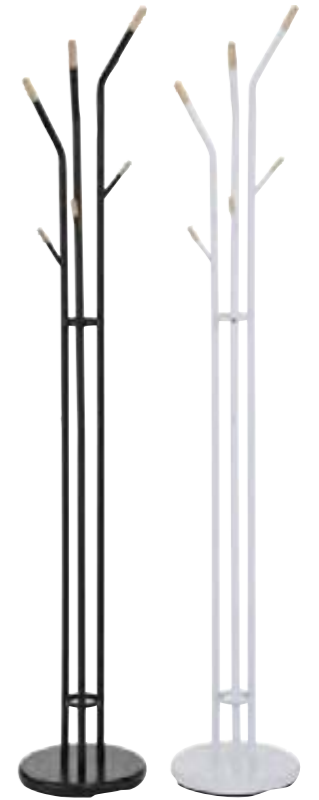

Sander

metal+drewno, czarny+buk, biały+buk
metal+wood, black+beech, white+beech
металл+древесина, черный+бук, белый+бук



Gent

metal, biały, czarny
metal, white, black
металл, белый, черный



Heron

metal, chrom, czarny
metal, chrome, black
металл, хром, черный

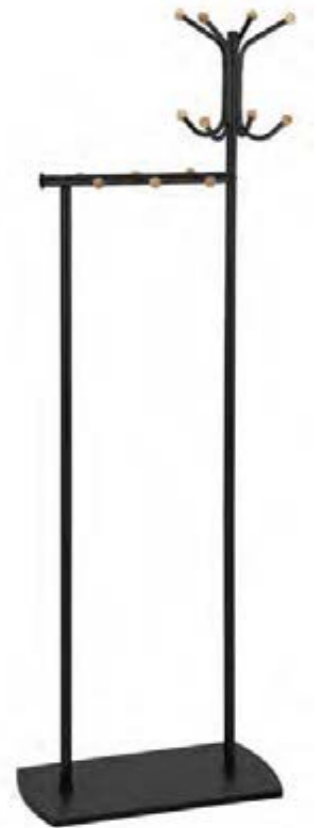

Simon

metal+drewno, kolor: czarny+buk
metal+wood, color: black+beech
металл+древесина, цвет: черный+бук





Otis 170 46
 metal, chrom, aluminium, czarny
 metal, chrome, aluminium, black
 металл, хром, алюминий, черный



Ria 179 30
 metal, chrom
 metal, chrome
 металл, хром

Bronson 178 28 28
 metal, kolor: czarny, chrom
 metal, color: black, chrome
 металл, цвет: черный, хром

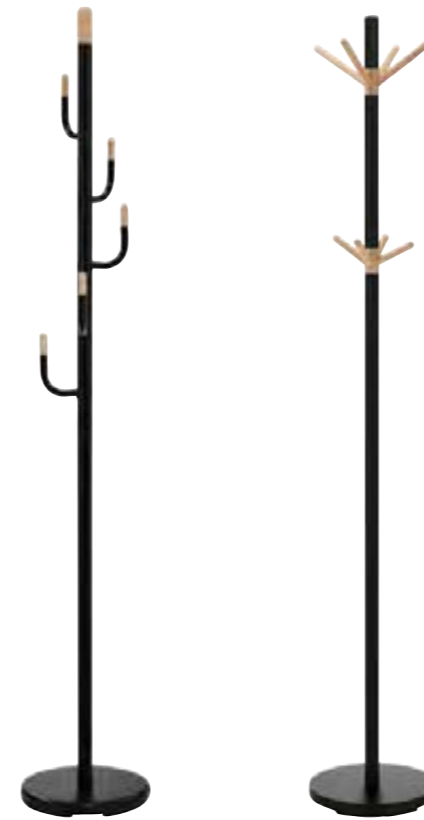

Cactus 179 28
 metal+drewno, czarny+buk
 metal+wood, black+beech
 металл+древесина, черный+бук

Uno 174 30
 metal+drewno, czarny+buk
 metal+wood, black+beech
 металл+древесина, черный+бук



Leta 174 30
 metal, czarny+chrom, czarny+zloty, biały+chrom
 metal, black+chrome, black+golden, white+chrome
 металл, черный+хром, черный+золотой, белый+хром

Allen 176 28
 metal, kolor: czarny+chrom
 metal, color: black+chrome
 металл, цвет: черный+хром

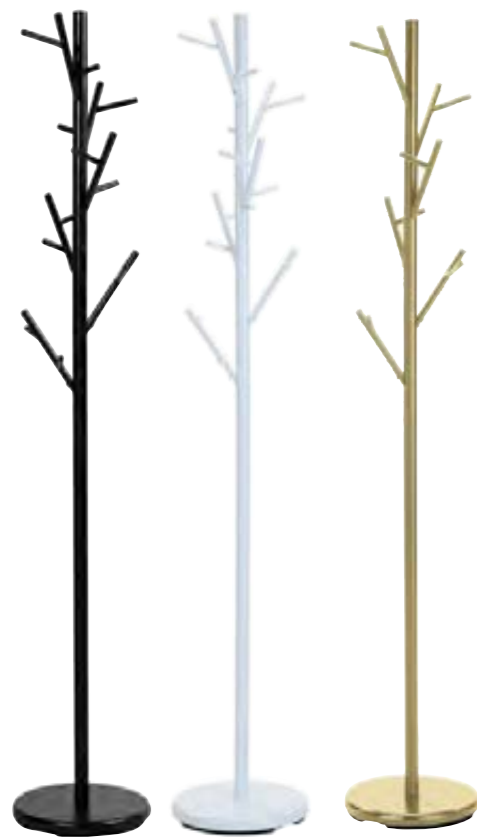

Zen 174 30
 metal, biały, czarny, zloty
 metal, white, black, golden
 металл, белый, черный, золотой



Eris 171 28
 metal, czarny, chrom, zloty, biały
 metal, black, chrome, golden, white
 металл, черный, хром, золотой, белый



Duke 175 28
 metal, biały, czarny, chrom
 metal, white, black, chrome
 металл, белый, черный, хром



Denis 176 30 30
 metal, kolor: zloty
 metal, color: golden
 металл, цвет: золотой

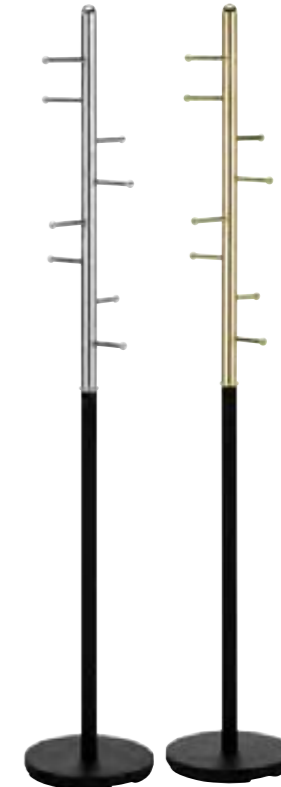

Ferro 173 30
 metal, czarny+zloty, czarny+chrom
 metal, black+golden, black+chrome
 металл, черный+золотой, черный+хром



Herrera Velvet

tkanina aksamit, kolor: antyczny róż, tap. Bluvel 52
 velvet fabric, color: antique rose, up. Bluvel 52
 ткань бархат, цвет: античный розовый, об. Bluvel 52

1. A - 225, B - 178, C - 160x200, D - 20, E - 6, F - 26, G - 47, H - 101



Herrera Velvet

tkanina aksamit, kolor: szary, tap. Bluvel 14
 velvet fabric, color: grey, up. Bluvel 14
 ткань бархат, цвет: серый, об. Bluvel 14

1. A - 225, B - 178, C - 160x200, D - 20, E - 6, F - 26, G - 47, H - 101



Santana Velvet

tkanina aksamit: szary, tap. Bluvel 14
 velvet fabric: grey, up. Bluvel 14
 ткань бархат: серый, об. Bluvel 14

1. A - 211, B - 170, C - 160x200, D - 15, E - 4, F - 23, G - 38, H - 127



Santana Velvet

tkanina aksamit, kolor: antyczny róż, tap. Bluvel 52
 velvet fabric, color: antique rose, up. Bluvel 52
 ткань бархат, цвет: античный розовый, об. Bluvel 52

1. A - 211, B - 170, C - 160x200, D - 15, E - 4, F - 23, G - 38, H - 127



Monako Velvet

tkanina aksamit, kolor: szary, tap. Bluvel 14
 velvet fabric, color: grey, up. Bluvel 14
 ткань бархат, цвет: серый, об. Bluvel 14

1. A - 217, B - 172, C - 160x200, D - 13, E - 4, F - 25, G - 39, H - 128



Carven Velvet

tkanina aksamit, kolor szary, tap. Bluvel 14
 velvet fabric, color: grey, up. Bluvel 14
 ткань бархат, цвет: серый, об. Bluvel 14

1. A - 225, B - 199, C - 160x200, D - 1, E - 5, F - 31, G - 34, H - 123



Mirage Velvet

tkanina aksamit, kolor: czarny, tap. 186
velvet fabric, color: black, up. 186
ткань бархат, цвет: черный, об. 186

1. A - 219, B - 165, C - 160x200, D - 13, E - 8, F - 21, G - 34, H - 108

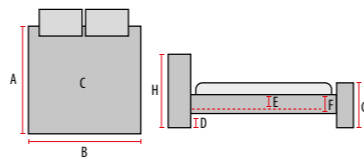

Emotion Velvet

tkanina aksamit, kolor: szary, tap. 142
velvet fabric, color: grey, up. 142
ткань бархат, цвет: серый, об. 142

1. A - 215, B - 170, C - 160x200, D - 5, E - 4, F - 31, G - 35, H - 122
2 szuflady / 2 drawers / 2 ящика



Liguria Velvet

tkanina aksamit: szary, tap. Bluvel 14
velvet fabric: grey, up. Bluvel 14
ткань бархат: серый, об. Bluvel 14

1. A - 221, B - 174, C - 160x200, D - 18, E - 4, F - 21, G - 39, H - 109

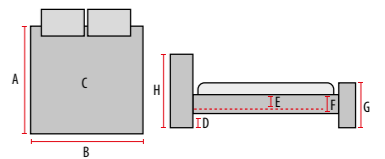

Calabria Velvet

tkanina aksamit: szary, tap. Bluvel 14
velvet fabric: grey, up. Bluvel 14
ткань бархат: серый, об. Bluvel 14

1. A - 222, B - 183, C - 160x200, D - 21, E - 4, F - 25, G - 46, H - 130





Nikozja Raven ^N

tkanina, kolor: ciemny beż, tap. Raven 28
 fabric, color: dark beige, up. Raven 28
 ткань, цвет: темный бежевый, об. Raven 28

A - 217, B - 179, C - 160x200, D - 13,5, E - 9,5, F - 25, G - 37, H - 114

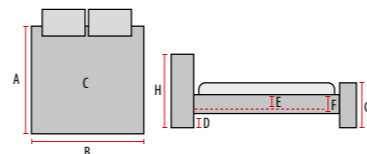

Nikozja Raven ^N

tkanina, kolor: jasny szary, tap. Raven 06
 fabric, color: light grey, up. Raven 06
 ткань, цвет: светлый серый, об. Raven 06

A - 217, B - 179, C - 160x200, D - 13,5, E - 9,5, F - 25, G - 37, H - 114



Belmont Raven ^N

tkanina, kolor: ciemny beż, tap. Raven 28
 fabric, color: dark beige, up. Raven 28
 ткань, цвет: темный бежевый, об. Raven 28

A - 202, B - 175, C - 160x200, D - 17, E - 6,6, F - 18, G - 35, H - 108

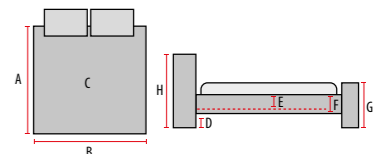

Belmont Raven ^N

tkanina, kolor: jasny szary, tap. Raven 06
 fabric, color: light grey, up. Raven 06
 ткань, цвет: светлый серый, об. Raven 06

A - 202, B - 175, C - 160x200, D - 17, E - 6,6, F - 18, G - 35, H - 108





Columbia Velvet ^N

tkanina aksamit, kolor: szary, tap. 192
 velvet fabric, color: grey, up. 192
 ткань бархат, цвет: серый, об. 192

- 1. A - 212, B - 147, C - 140x200, D - 5, E - 4, F - 23, G - 28, H - 86
 - 2. A - 212, B - 167, C - 160x200, D - 5, E - 4, F - 23, G - 28, H - 86
- pojemnik | storage | контейнер

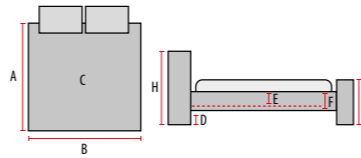

Columbia Velvet ^N

tkanina aksamit, kolor: beż, tap. Bluvel 28
 velvet fabric, color: beige, up. Bluvel 28
 ткань бархат, цвет: бежевый, об. Bluvel 28

- 1. A - 212, B - 147, C - 140x200, D - 5, E - 4, F - 23, G - 28, H - 86
 - 2. A - 212, B - 167, C - 160x200, D - 5, E - 4, F - 23, G - 28, H - 86
- pojemnik | storage | контейнер



Montreal Velvet

tkanin aksamit, kolor: szary, tap. 192
 velvet fabric, color: grey, up. 192
 ткань бархат, цвет: серый, об. 192

NOWY WYMIAR

- 1. A - 215, B - 97, C - 90x200, D - 3, E - 4, F - 23, G - 26, H - 79
 - 2. A - 215, B - 127, C - 120x200, D - 3, E - 4, F - 23, G - 26, H - 79
 - 3. A - 215, B - 147, C - 140x200, D - 3, E - 4, F - 23, G - 26, H - 79
 - 4. A - 215, B - 167, C - 160x200, D - 3, E - 4, F - 23, G - 26, H - 79
- pojemnik | storage | контейнер

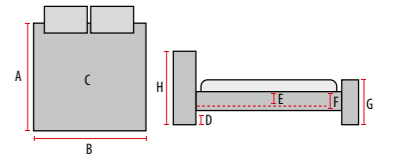

Montreal Velvet ^N

tkanina aksamit, kolor: beż, tap. Bluvel 28
 velvet fabric, color: beige, up. Bluvel 28
 ткань бархат, цвет: бежевый, об. Bluvel 28

- 1. A - 215, B - 97, C - 90x200, D - 3, E - 4, F - 23, G - 26, H - 79
 - 2. A - 215, B - 127, C - 120x200, D - 3, E - 4, F - 23, G - 26, H - 79
 - 3. A - 215, B - 147, C - 140x200, D - 3, E - 4, F - 23, G - 26, H - 79
 - 4. A - 215, B - 167, C - 160x200, D - 3, E - 4, F - 23, G - 26, H - 79
- pojemnik | storage | контейнер





Azurre Velvet

tkanina, kolor: zielony, tap. Bluvel 78
fabric, color: green, up. Bluvel 78
ткань, цвет: зеленый, об. Bluvel 78

- 1. A - 206, B - 165, C - 160x200, D - 15, E - 6, F - 18, G - 36, H - 96
- 2. A - 206, B - 185, C - 180x200, D - 15, E - 6, F - 18, G - 36, H - 96

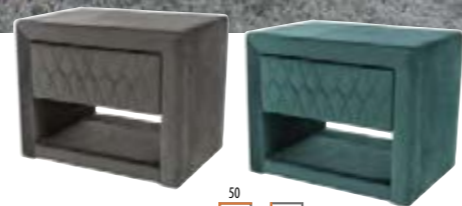

Azurre Velvet

szafka nocna | nightstand | тумбочка

- 1. A - 206, B - 145, C - 140x200, D - 15, E - 6, F - 18, G - 36, H - 96
- 2. A - 206, B - 165, C - 160x200, D - 15, E - 6, F - 18, G - 36, H - 96

Azurre Velvet

tkanina, kolor: szary, tap. Bluvel 14
fabric, color: grey, up. Bluvel 14
ткань, цвет: серый, об. Bluvel 14



Savana Velvet

tkanina aksamit, kolor: szary, tap. 192
velvet fabric, color: grey, up. 192
ткань бархат, цвет: серый, об. 192

- 1. A - 214, B - 101, C - 90x200, D - 15, E - 4, F - 14, G - 29, H - 102
- 2. A - 214, B - 131, C - 120x200, D - 15, E - 4, F - 14, G - 29, H - 102
- 3. A - 214, B - 151, C - 140x200, D - 15, E - 4, F - 14, G - 29, H - 102
- 4. A - 214, B - 171, C - 160x200, D - 15, E - 4, F - 14, G - 29, H - 102

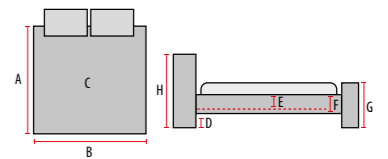

Savana Velvet

tkanina aksamit, kolor: beż, tap. Bluvel 28
velvet fabric, color: beige, up. Bluvel 28
ткань бархат, цвет: бежевый, об. Bluvel 28

- 1. A - 214, B - 101, C - 90x200, D - 15, E - 4, F - 14, G - 29, H - 102
- 2. A - 214, B - 131, C - 120x200, D - 15, E - 4, F - 14, G - 29, H - 102
- 3. A - 214, B - 151, C - 140x200, D - 15, E - 4, F - 14, G - 29, H - 102
- 4. A - 214, B - 171, C - 160x200, D - 15, E - 4, F - 14, G - 29, H - 102





Sierra Velvet

tkanina aksamit, kolor: jasny szary, tap. Bluvel 03
 velvet fabric, color: light grey, up. Bluvel 03
 ткань бархат, цвет: светлый серый 03, об. Bluvel 03

A - 213, B - 126, C - 120x200, D - 10, E - 5, F - 18, G - 31, H - 91

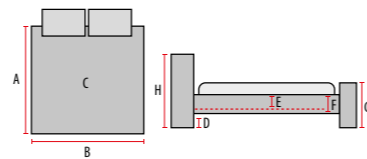

Acoma

tkanina, kolor: szary, tap. 131
 fabric, color: grey, up. 131
 ткань, цвет: серый, об. 131

A - 215, B - 167, C - 160x200, D - 15, E - 7, F - 17, G - 36, H - 105



Sierra Velvet

tkanina aksamit, kolor: beż, tap. Bluvel 28
 velvet fabric, color: beige, up. Bluvel 28
 ткань бархат, цвет: бежевый, об. Bluvel 28

- NOWY WYMIAR** 1. A - 213, B - 96, C - 90x200, D - 10, E - 5, F - 18, G - 31, H - 91
NOWY WYMIAR 2. A - 213, B - 126, C - 120x200, D - 10, E - 5, F - 18, G - 31, H - 91
NOWY WYMIAR 3. A - 213, B - 146, C - 140x200, D - 10, E - 5, F - 18, G - 31, H - 91
 4. A - 213, B - 166, C - 160x200, D - 10, E - 5, F - 18, G - 31, H - 91

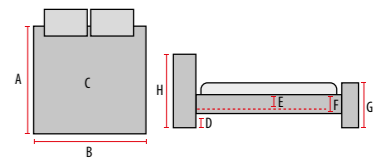

Sierra Velvet

tkanina aksamit: szary, tap. 150
 velvet fabric: grey, up. 150
 ткань бархат: серый, об. 150

- NOWY WYMIAR** 1. A - 213, B - 96, C - 90x200, D - 10, E - 5, F - 18, G - 31, H - 91
NOWY WYMIAR 2. A - 213, B - 126, C - 120x200, D - 10, E - 5, F - 18, G - 31, H - 91
NOWY WYMIAR 3. A - 213, B - 146, C - 140x200, D - 10, E - 5, F - 18, G - 31, H - 91
 4. A - 213, B - 166, C - 160x200, D - 10, E - 5, F - 18, G - 31, H - 91





Aspen Velvet

tkanina aksamit, kolor: szary, tap. Bluvel 14
velvet fabric, color: grey, up. Bluvel 14
ткань бархат, цвет: серый, об. Bluvel 14

1. A - 216, B - 108, C - 90x200, D - 10, E - 5, F - 26, G - 36, H - 124
2. A - 216, B - 178, C - 160x200, D - 10, E - 5, F - 26, G - 36, H - 124
3. A - 216, B - 198, C - 180x200, D - 10, E - 5, F - 26, G - 36, H - 124

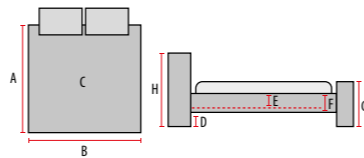

Aspen Velvet

tkanina aksamit, kolor: beż, tap. Bluvel 28
velvet fabric, color: beige, up. Bluvel 28
ткань бархат, цвет: бежевый, об. Bluvel 28

A - 216, B - 178, C - 160x200, D - 10, E - 5, F - 26, G - 36, H - 124



Aspen Velvet

tkanina aksamit, kolor: czarny, tap. Bluvel 19
velvet fabric, color: black, up. Bluvel 19
ткань бархат, цвет: черный, об. Bluvel 19

A - 216, B - 178, C - 160x200, D - 10, E - 5, F - 26, G - 36, H - 111



Aspen Velvet

tkanina aksamit, kolor: bordowy, tap. Bluvel 59
velvet fabric, color: claret, up. Bluvel 59
ткань бархат, цвет: бордовый, об. Bluvel 59

A - 216, B - 178, C - 160x200, D - 10, E - 5, F - 26, G - 36, H - 124



Aspen Velvet

tkanina aksamit, kolor: zielony, tap. Bluvel 78
velvet fabric, color: green, up. Bluvel 78
ткань бархат, цвет: зеленый, об. Bluvel 78

1. A - 216, B - 178, C - 160x200, D - 10, E - 5, F - 26, G - 36, H - 124
2. A - 216, B - 198, C - 180x200, D - 10, E - 5, F - 26, G - 36, H - 124



Electra Velvet

tkanina aksamit: szary, tap. 76
velvet fabric: grey, up. 76
ткань бархат: серый, об. 76

1. A - 217, B - 145, C - 140x200, D - 5, E - 6, F - 30, G - 39, H - 111
2. A - 217, B - 165, C - 160x200, D - 5, E - 6, F - 30, G - 39, H - 111
3. A - 217, B - 185, C - 180x200, D - 5, E - 6, F - 30, G - 39, H - 111

4 szuflady / 4 drawers / 4 ящика



Aspen Velvet

tkanina aksamit, kolor: szary, tap. Bluvel 14
velvet fabric, color: grey, up. Bluvel 14
ткань бархат, цвет: серый, об. Bluvel 14

A - 216, B - 108, C - 90x200, D - 10, E - 5, F - 26, G - 36, H - 124



Electra Velvet

tkanina aksamit: szary, tap. 142
velvet fabric: grey, up. 142
ткань бархат: серый, об. 142

A - 217, B - 165, C - 160x200, D - 5, E - 6, F - 30, G - 39, H - 111

4 szuflady / 4 drawers / 4 ящика



Aspen II Velvet

tkanina aksamit, kolor: szary, tap. Bluvel 14
velvet fabric, color: grey, up. Bluvel 14
ткань бархат, цвет: серый, об. Bluvel 14

A - 219, B - 178, C - 160x200, D - 5, E - 7, F - 31, G - 39, H - 124

4 szuflady / 4 drawers / 4 ящика



Ascot

tkanina, kolor: szary, tap. 23
 fabric, color: grey, up. 23
 ткань, цвет: серый, об. 23

1. A - 221, B - 173, C - 160x200, D - 10, E - 4, F - 25, G - 39, H - 101
 2 szuflady / 2 drawers / 2 ящика

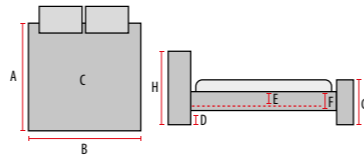

Texas

tkanina, kolor: szary, tap. 23
 fabric, color: grey, up. 23
 ткань, цвет: серый, об. 23

1. A - 220, B - 139, C - 120x200, D - 15, E - 5, F - 21, G - 37, H - 103
 2. A - 220, B - 159, C - 140x200, D - 15, E - 7, F - 22, G - 37, H - 103
 3. A - 220, B - 179, C - 160x200, D - 15, E - 7, F - 22, G - 37, H - 103
 4. A - 220, B - 199, C - 180x200, D - 15, E - 7, F - 22, G - 37, H - 103



Barcelona

tkanina, kolor: szary, tap. 23
 fabric, color: grey, up. 23
 ткань, цвет: серый, об. 23

1. A - 216, B - 168, C - 160x200, D - 9, E - 10, F - 31, G - 42, H - 94

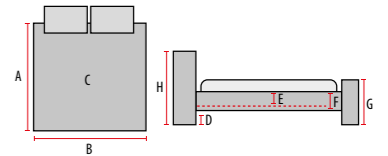

Aspen

tkanina, kolor: szary, tap. 23
 fabric, color: grey, up. 23
 ткань, цвет: серый, об. 23

1. A - 216, B - 158, C - 140x200, D - 10, E - 5, F - 26, G - 36, H - 124
 2. A - 216, B - 178, C - 160x200, D - 10, E - 5, F - 26, G - 36, H - 124





Marani Velvet

tkanina aksamit, kolor: szary, tap. Bluvel 14
velvet fabric, color: grey, up. Bluvel 14
ткань бархат, цвет: серый, об. Bluvel 14

rojemnik | storage | контейнер

A - 216, B - 173, C - 160x200, D - 6, E - 5, F - 34, G - 40, H - 110



Maison Velvet

tkanina aksamit, kolor: szary, tap. Bluvel 14
velvet fabric, color: grey, up. Bluvel 14
ткань бархат, цвет: серый, об. Bluvel 14

rojemnik | storage | контейнер

A - 216, B - 178, C - 160x200, D - 10, E - 5, F - 26, G - 36, H - 124



Siena

metal, kolor: biały
metal, color: white
металл, цвет: белый

1. A - 206, B - 121, C - 120x200, D - 28, E - 3, F - 5, G - 71, H - 102
2. A - 206, B - 142, C - 140x200, D - 28, E - 3, F - 5, G - 71, H - 102



Florence

metal, kolor: biały
metal, color: white
металл, цвет: белый

1. A - 206, B - 121, C - 120x200, D - 28, E - 3, F - 5, G - 64, H - 101
2. A - 206, B - 142, C - 140x200, D - 28, E - 3, F - 5, G - 64, H - 101



Marani Velvet

tkanina aksamit, kolor: ciemny beż, tap. Bluvel 40
velvet fabric, color: dark beige, up. Bluvel 40
ткань бархат, цвет: темный бежевый, об. Bluvel 40

rojemnik | storage | контейнер

A - 216, B - 173, C - 160x200, D - 6, E - 5, F - 34, G - 40, H - 110



Maison Velvet

tkanina aksamit, kolor: ciemny beż, tap. Bluvel 40
velvet fabric, color: dark beige, up. Bluvel 40
ткань бархат, цвет: темный бежевый, об. Bluvel 40

rojemnik | storage | контейнер

A - 216, B - 178, C - 160x200, D - 10, E - 5, F - 26, G - 36, H - 124H - 124



Bolonia

metal, kolor: czarny
metal, color: black
металл, цвет: черный

1. A - 206, B - 92, C - 90x200, D - 28, E - 3, F - 5, G - 51, H - 102
2. A - 206, B - 142, C - 140x200, D - 28, E - 3, F - 5, G - 51, H - 102



Bolonia

metal, kolor: biały
metal, color: white
металл, цвет: белый

1. A - 206, B - 92, C - 90x200, D - 28, E - 3, F - 5, G - 51, H - 102
2. A - 206, B - 142, C - 140x200, D - 28, E - 3, F - 5, G - 51, H - 102



Marani Velvet



Maison Velvet



Venecja

drewno+metal, kolor: czarny+czereśnia antyczna
wood+metal, color: black+antique cherry
дерево+металл, цвет: черный+черешня античная

1. A - 217, B - 142, C - 140x200, D - 28, E - 3, F - 5, G - 75, H - 102
2. A - 217, B - 162, C - 160x200, D - 28, E - 3, F - 5, G - 75, H - 102

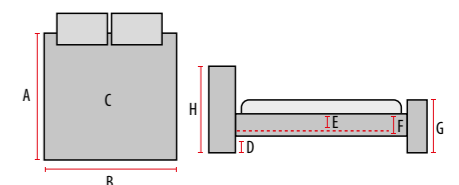



Savana Velvet N

tkanina aksamit, kolor: szary, tap. 192
 velvet fabric, color: grey, up. 192
 ткань бархат, цвет: серый, об. 192

A - 214, B - 101, C - 90x200, D - 15, E - 4, F - 14, G - 29, H - 102

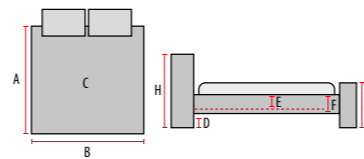

Savana Velvet N

tkanina aksamit, kolor: beż, tap. Bluvel 28
 velvet fabric, color: beige, up. Bluvel 28
 ткань бархат, цвет: бежевый, об. Bluvel 28

A - 214, B - 101, C - 90x200, D - 15, E - 4, F - 14, G - 29, H - 102



Montreal Velvet N

tkanina aksamit, kolor: szary, tap. 192
 velvet fabric, color: grey, up. 192
 ткань бархат, цвет: серый, об. 192

A - 215, B - 97, C - 90x200, D - 3, E - 4, F - 23, G - 26, H - 79
 pojemnik | storage | контейнер

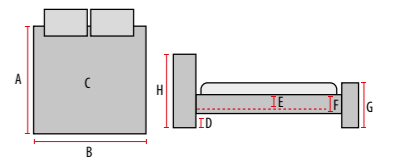

Montreal Velvet N

tkanina aksamit, kolor: beż, tap. Bluvel 28
 velvet fabric, color: beige, up. Bluvel 28
 ткань бархат, цвет: бежевый, об. Bluvel 28

A - 215, B - 97, C - 90x200, D - 3, E - 4, F - 23, G - 26, H - 79
 pojemnik | storage | контейнер





Polly Velvet ^N

tkanina aksamit, kolor: antyczny róż, tap. Bluvel 52
 velvet fabric, color: antique rose, up. Bluvel 52
 ткань бархат, цвет: античный розовый, об. Bluvel 52

A - 214, B - 126, C - 120x200, D - 2, E - 5, F - 34, G - 34, H - 118
 pojemnik | storage | контейнер

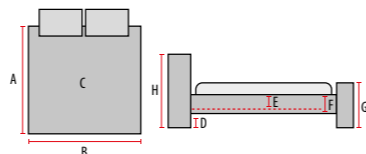

Polly Velvet ^N

tkanina aksamit, kolor: ciemny beż, tap. Bluvel 40
 velvet fabric, color: dark beige, up. Bluvel 40
 ткань бархат, цвет: темный бежевый, об. Bluvel 40

A - 214, B - 126, C - 120x200, D - 2, E - 5, F - 34, G - 34, H - 118
 pojemnik | storage | контейнер



Mirage Velvet

tkanina aksamit, kolor: antyczny róż, tap. 185
 velvet fabric, color: antique rose, up. 185
 ткань бархат, цвет: античный розовый, об. 185

A - 219, B - 95, C - 90x200, D - 13, E - 8, F - 21, G - 34, H - 108

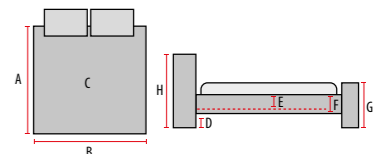

Chloe Velvet

tkanina aksamit, kolor: antyczny róż, tap. Bluvel 52
 velvet fabric, color: antique rose, up. Bluvel 52
 ткань бархат, цвет: античный розовый, об. Bluvel 52

A - 215, B - 104, C - 90x200, D - 15, E - 7, F - 18, G - 33, H - 106





Texas Velvet

tkanina aksamit, kolor: antyczny róż, tap. Bluvel 52
 velvet fabric, color: antique rose, up. Bluvel 52
 ткань бархат, цвет: античный розовый, об. Bluvel 52

A - 220, B - 139, C - 90x200, D - 15, E - 5, F - 21, G - 37, H - 103

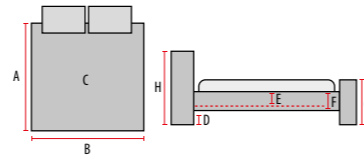

Texas Velvet

tkanina aksamit, kolor: szary, tap. Bluvel 14
 velvet fabric, color: grey, up. Bluvel 14
 ткань бархат, цвет: серый, об. Bluvel 14

A - 220, B - 139, C - 90x200, D - 15, E - 5, F - 21, G - 37, H - 103



Sierra Velvet N

tkanina aksamit, kolor: beż, tap. Bluvel 28
 velvet fabric, color: beige, up. Bluvel 28
 ткань бархат, цвет: бежевый, об. Bluvel 28

A - 213, B - 96, C - 90x200, D - 10, E - 5, F - 18, G - 31, H - 91

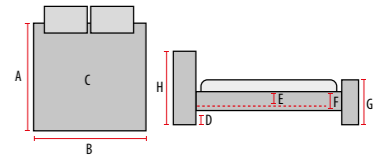

Sierra Velvet N

tkanina aksamit, kolor: szary, tap. 150
 velvet fabric, color: grey, up. 150
 ткань бархат, цвет: серый, об. 150

A - 213, B - 96, C - 90x200, D - 10, E - 5, F - 18, G - 31, H - 91





Azurre Velvet

tkanina, kolor: szary, tap. Bluvel 14
fabric, color: grey, up. Bluvel 14
ткань, цвет: серый, об. Bluvel 14

A - 206, B - 96, C - 90x200, D - 15, E - 5, F - 18, G - 36, H - 96



Azurre Velvet 40 50 35
szafka nocna | nightstand | тумбочка

Azurre Velvet

tkanina, kolor: zielony, tap. Bluvel 78
fabric, color: green, up. Bluvel 78
ткань, цвет: зеленый, об. Bluvel 78

A - 206, B - 96, C - 90x200, D - 15, E - 5, F - 18, G - 36, H - 96



Acoma Velvet

tkanina aksamit, kolor: antyczny róż, tap. Bluvel 52
velvet fabric, color: antique rose, up. Bluvel 52
ткань бархат, цвет: античный розовый, об. Bluvel 52

A - 215, B - 97, C - 90x200, D - 15, E - 7, F - 17, G - 36, H - 93

Acoma

tkanina, kolor: szary, tap. 131
fabric, color: grey, up. 131
ткань, цвет: серый, об. 131

A - 215, B - 97, C - 90x200, D - 15, E - 7, F - 17, G - 36, H - 93

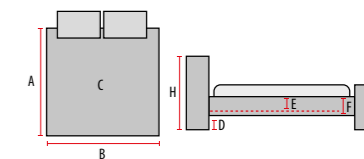



Aspen Velvet

tkanina aksamit, kolor: antyczny róż, tap. Bluvel 52, szary, tap. Bluvel 14
 velvet fabric, color: antique rose, up. Bluvel 52, grey, up. Bluvel 14
 ткань бархат, цвет: античный розовый, об. Bluvel 52, серый, об. Bluvel 14

A - 216, B - 108, C - 90x200, D - 10, E - 5, F - 26, G - 36,
 H - 124

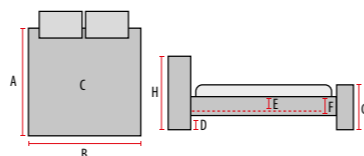

Tiffany

tkanina, kolor: szary, tap. 57
 fabric, color: grey, up. 57
 ткань, цвет: серый, об. 57

A - 217, B - 111, C - 90x200, D - 15, E - 6, F - 17, G - 40, H - 105



Bella Velvet

tkanina aksamit, kolor: antyczny róż, tap. Bluvel 52
 velvet fabric, color: antique rose, up. Bluvel 52
 ткань бархат, цвет: античный розовый, об. Bluvel 52

A - 214, B - 102, C - 90x200, D - 3, E - 4, F - 17, G - 46,
 H - 116

dotatkowa powierzchnia spania max. 90x195x18
 additional sleeping area max. 90x195x18
 дополнительная спальная зона макс. 90x195x18

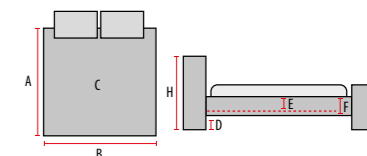

Bella Velvet

tkanina aksamit, kolor: szary, tap. Bluvel 14
 velvet fabric, color: grey, up. Bluvel 14
 ткань бархат, цвет: серый, об. Bluvel 14

A - 214, B - 102, C - 90x200, D - 3, E - 4, F - 17, G - 46,
 H - 116

dotatkowa powierzchnia spania max. 90x195x18
 additional sleeping area max. 90x195x18
 дополнительная спальная зона макс. 90x195x18





Elmo Velvet ^N

tkanina aksamit, kolor: ciemny beż, tap. Bluelvel 40
 velvet fabric, color: dark beige, up. Bluelvel 40
 ткань бархат, цвет: темный бежевый, об. Bluelvel 40

A - 131, B - 214, C - 120x200, D - 2, E - 7, F - 44, G - 70, H - 70
 dodatkowa powierzchnia spania max. 120x200x18
 additional sleeping area max. 120x200x18
 дополнительная спальная зона макс. 120x200x18

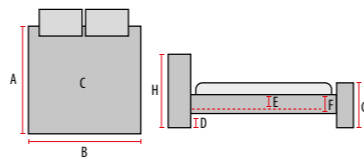

Elmo Velvet ^N

tkanina aksamit, kolor: szary, tap. Bluelvel 14
 velvet fabric, color: grey, up. Bluelvel 14
 ткань бархат, цвет: серый, об. Bluelvel 14

A - 131, B - 214, C - 120x200, D - 2, E - 7, F - 44, G - 70, H - 70
 dodatkowa powierzchnia spania max. 120x200x18
 additional sleeping area max. 120x200x18
 дополнительная спальная зона макс. 120x200x18



Alfie Velvet ^N

tkanina aksamit, kolor: ciemny beż, tap. Bluelvel 40
 velvet fabric, color: dark beige, up. Bluelvel 40
 ткань бархат, цвет: темный бежевый, об. Bluelvel 40

A - 133, B - 216, C - 120x200, D - 2, F - 48, G - 44, H - 95
 dodatkowa powierzchnia spania max. 120x200x18
 additional sleeping area max. 120x200x18
 дополнительная спальная зона макс. 120x200x18

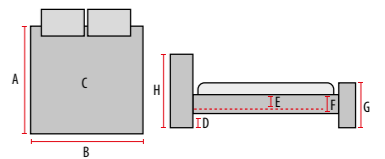

Alfie Velvet ^N

tkanina aksamit, kolor: szary, tap. Bluelvel 14
 velvet fabric, color: grey, up. Bluelvel 14
 ткань бархат, цвет: серый, об. Bluelvel 14

A - 133, B - 216, C - 120x200, D - 2, F - 48, G - 44, H - 95
 dodatkowa powierzchnia spania max. 120x200x18
 additional sleeping area max. 120x200x18
 дополнительная спальная зона макс. 120x200x18



uniwersalne ustawienie (lewe / prawe)
 universal setting (left / right)
 универсальная настройка (левая / правая)



Eliot Velvet NOWY KOLOR

tkanina aksamit, kolor: c. beż, tap. 228
 velvet fabric, color: d. beige, up. 228
 ткань бархат, цвет: т. бежевый, об. 228

A - 128, B - 213, C - 120x200, D - 5, E - 4, F - 44, G - 75
 2 szuflady / 2 drawers / 2 ящика

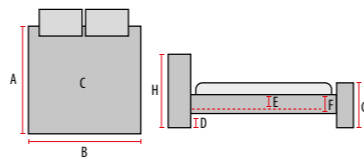

Eliot Velvet

tkanina aksamit, kolor: szary, tap. 142
 velvet fabric, color: grey, up. 142
 ткань бархат, цвет: серый, об. 142

A - 128, B - 213, C - 120x200, D - 5, E - 4, F - 44, G - 75
 2 szuflady / 2 drawers / 2 ящика



Nadia Velvet NOWY KOLOR

tkanina aksamit, kolor: c. beż, tap. 228
 velvet fabric, color: d. beige, up. 228
 ткань бархат, цвет: т. бежевый, об. 228

A - 127, B - 213, C - 120x200, D - 5, E - 4, F - 44, G - 86
 2 szuflady / 2 drawers / 2 ящика

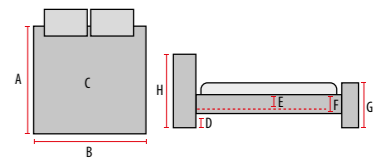

Nadia Velvet

tkanina aksamit, kolor: szary, tap. 142
 velvet fabric, color: grey, up. 142
 ткань бархат, цвет: серый, об. 142

A - 127, B - 213, C - 120x200, D - 5, E - 4, F - 44, G - 86
 2 szuflady / 2 drawers / 2 ящика





Lanta

tkanina, kolor: szary, tap. 54
 fabric, color: grey, up. 54
 ткань, цвет: серый, об. 54

A - 222, B - 98, C - 90x200, D - 5, E - 12, F - 22, G - 44, H - 81
 2 szuflady / 2 drawers / 2 ящика

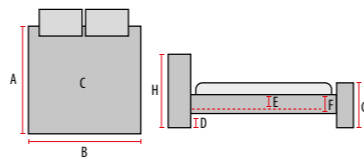

Alessia

tkanina, kolor: szary, tap. 23
 fabric, color: grey, up. 23
 ткань, цвет: серый, об. 23

A - 214, B - 100, C - 90x200, D - 3, E - 9, F - 47, G - 50, H - 92
 dodatkowa powierzchnia spania max. 90x195x18
 additional sleeping area max. 90x195x18
 дополнительная спальная зона макс. 90x195x18



Lanta Velvet NOWY KOLOR

tkanina aksamit, kolor: c. beż, tap. 228
 velvet fabric, color: d. beige, up. 228
 ткань бархат, цвет: т. бежевый, об. 228

A - 222, B - 98, C - 90x200, D - 5, E - 12, F - 22, G - 44, H - 81
 2 szuflady / 2 drawers / 2 ящика

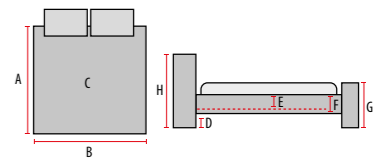

Lanta Velvet NOWY KOLOR

tkanina aksamit, kolor: szary, tap. 142
 velvet fabric, color: grey, up. Bluelvel 142
 ткань бархат, цвет: серый, об. Bluelvel 142

A - 222, B - 98, C - 90x200, D - 5, E - 12, F - 22, G - 44, H - 81
 2 szuflady / 2 drawers / 2 ящика





Bolonia N

metal, kolor: czarny
metal, color: black
металл, цвет: черный

A - 206, B - 94, C - 90x200, D - 28, E - 3, F - 5, G - 51, H - 102

Bolonia N

metal, kolor: biały
metal, color: white
металл, цвет: белый

A - 206, B - 94, C - 90x200, D - 28, E - 3, F - 5, G - 51, H - 102



Birma

metal, kolor: biały
metal, color: white
металл, цвет: белый

1. A - 208, B - 96, C - 90x200, D - 30, E - 2, F - 5, G - 90, H - 100



Birma

metal, kolor: czarny
metal, color: black
металл, цвет: черный

1. A - 208, B - 96, C - 90x200, D - 30, E - 2, F - 5, G - 90, H - 100



ET-920

szafka nocna, szkło / metal kolor: biały
nightstand, glass / metal, color: white
тумбочка, стекло / металл, цвет: белый



Azurro Velvet

szafka nocna, tkanina aksamit, tap. Bluvel 78, 14
nightstand, velvet fabric, color: up. Bluvel 78, 14
тумбочка, ткань бархат, об. Bluvel 78, 14



Monako Velvet

szafka nocna, tkanina aksamit, kolor: antyczny róż, tap. Bluvel 52 / metal, kolor: złoty
nightstand, velvet fabric, color: antique rose, up. Bluvel 52 / metal, color: golden
тумбочка, ткань бархат, цвет: античный розовый, об. Bluvel 52 / металл, цвет: золотой



ET-001

szafka nocna / nightstand / тумбочка



ET-002

szafka nocna / nightstand / тумбочка



ET-003

szafka nocna / nightstand / тумбочка

ET Velvet

szafka nocna, tkanina aksamit Bluvel, kolory: szary 14, antyczny róż 52, beż 28, zielony 78, jasny szary 03
nightstand, velvet fabric Bluvel, colors: grey 14, antique rose 52, beige 28, green 78, light grey 03
тумбочка, ткань бархат Bluvel, цвет: серый 14, античный розовый 52, бежевый 28, зеленый 78, светлый серый 03



M1

materac piankowy / foam mattress / поролоновый матрас
WKŁAD: pianka komfortowa - 10 cm, **POKROWIEC:** tkanina Tender (100% poliester) pikowany owatą antyalergiczną o gramaturze 120 g/m², zamek rozdzielczy, wysokość: ok. 10 cm, twardość: 4/5

INPUT: comfort foam - 10cm, **COVER:** Tender fabric (100% polyester) fabric quilted with antiallergic non woven with a weight of 120 g/m², distribution zipper, height: about 10 cm, hardness: 4/5

НАПОЛНЕНИЕ: комфортная пена - 10см, **ЧЕХОЛ:** Tender ткань (100% полиэстер) ткань простегана антиаллергенным нетканым материалом плотностью 120 г/м², застежка-молния, высота: около 10 см, жесткость: 4/5

M2

materac bonellowy / bonnell mattress / матрас боннель
WKŁAD: sprężyna typu bonnell 11 cm, przekładki tapicerskie, pianka komfortowa - 2 cm, **POKROWIEC:** tkanina Tender (100% poliester) pikowany owatą antyalergiczną o gramaturze 120 g/m², zamek rozdzielczy, wysokość: około 16 cm, twardość: 3/5

INPUT: bonnell spring with spacers, comfort foam - 2 cm, **COVER:** Tender fabric (100% polyester) fabric quilted with antiallergic non woven with a weight of 120 g/m², distribution zipper, height: about 16 cm, hardness: 3/5

НАПОЛНЕНИЕ: пружины bonell, комфортная пена - 2 см, **ЧЕХОЛ:** Tender ткань (100% полиэстер) ткань простегана антиаллергенным нетканым материалом плотностью 120 г/м², застежка-молния, высота: около 16 см, жесткость: 3/5



Jadeit

materac / mattress / матрас
WKŁAD: sprężyny kieszeniowe 7-strefowe (ok 200 sprężyn na m²) - 15 cm, przekładka tapicerska, pianka komfortowa (gęstość ok. 25 kg/m³) - 2 cm, **POKROWIEC:** tkanina Tender (100% poliester) pikowany owatą antyalergiczną o gramaturze 120 g/m², zamek rozdzielczy, wysokość: około 20 cm, twardość: 3/5

INPUT: 7-zone pocket springs with spacers - 15 cm, comfort foam - 2 cm, **COVER:** Tender fabric (100% polyester) fabric quilted with antiallergic non woven with a weight of 120 g/m², distribution zipper, height: about 20 cm, hardness: 3/5

НАПОЛНЕНИЕ: пружины карманного типа - 15 см, комфортная пена - 2 см, **ЧЕХОЛ:** Tender ткань (100% полиэстер) ткань простегана антиаллергенным нетканым материалом плотностью 120 г/м², застежка-молния, высота: около 20 см, жесткость: 3/5





Peggie N

tkanina, kolor: szary, tap. 234 / beż, tap. 235 / metal, chrom
 fabric, color: grey, up. 234 / beige, up. 235 / metal, chrome
 ткань, цвет: серый, об. 234 / бежевый, об. 235 / металл, хром
 A - 87, B - 75, C - 48, D - 50, E - 90, F - 38



Felicia Raven N

tkanina Raven / skóra syntetyczna, kolor: cynamon 44 / brąz, tap. 233 / metal, czarny mat
 fabric Raven / synthetic leather, color: cinnamon 44 / brown, up. 233 / metal, black mat
 ткань Raven / искусственная кожа, цвет: корица 44 / коричневый, об. 233 / металл, черный матовый
 A - 91, B - 79, C - 45, D - 56, E - 87, F - 25



Giselle N

tkanina / skóra syntetyczna, kolor: róż antyczny, tap. 236 / beż, tap. 237 / metal, czarny mat, TILT
 fabric / synthetic leather, color: antique rose, up. 236 / beige, up. 237 / metal, black mat, TILT
 ткань / искусственная кожа, цвет: античный розовый, об. 236 / бежевый, об. 237 / металл, черный матовый, TILT
 A - 101, B - 77, C - 46, D - 53, E - 90, F - 24



Betty N

tkanina / skóra syntetyczna, kolor: róż antyczny, tap. 236 / beż, tap. 237 / metal, chrom
 fabric / synthetic leather, color: antique rose, up. 236 / beige, up. 237 / metal, chrome
 ткань / искусственная кожа, цвет: античный розовый, об. 236 / бежевый, об. 237 / металл, хром
 A - 83, B - 73, C - 44, D - 50, E - 87, F - 22



Harper N

tkanina, kolor: oliwkowy, tap. 238 / metal, czarny mat, TILT
 fabric, color: olive, up. 238 / metal, black mat, TILT
 ткань, цвет: оливковый, об. 238 / металл, черный матовый, TILT
 A - 101, B - 77, C - 48, D - 54, E - 83, F - 25



Brigitte Brego N

tkanina: Brego, kolor: curry 68 / metal, chrom
 fabric: Brego, colors: curry 68 / metal, chrome
 ткань: Brego, цвет: карри 68 / металл, хром
 A - 83, B - 77, C - 45, D - 62, E - 87, F - 20

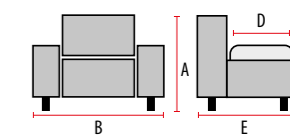



Regan

tkanina, kolory: morski, tap. 177, szary, tap. 176 / metal, stal szcztokowa, mechanizm TILT
 fabric, colors: sea-blue, up. 177, grey, up. 176 / metal, brushed steel, TILT mechanism
 ткань, цвет: морской, об. 177, серый, об. 176 / металл, матовая сталь, механизм Тилт
 1. A - 104, B - 75, C - 46, D - 48, E - 80 | 2. A - 40, B - 48, C - 42



Ford Velvet

tkanina aksamit: Bluvel, kolory: szary 14, turkusowy 85 / metal, kolor: czarny, mechanizm TILT
 velvet fabric Bluvel, colors: grey 14, turquoise 85 / metal, color: black, TILT mechanism
 ткань бархат Bluvel, цвет: серый 14, бирюзовый 85 / металл, цвет: черный, механизм Тилт
 1. A - 108, B - 75, C - 45, D - 51, E - 82 | 2. A - 40, B - 47, C - 43



Monroe Velvet

tkanina aksamit: Bluvel, kolor: antyczny róż 52 / metal, stal szcztokowa, mechanizm TILT
 velvet fabric: Bluvel, color: antique rose 52 / metal, brushed steel, TILT mechanism
 ткань бархат: Bluvel, цвет: античный розовый 52 / металл, матовая сталь, механизм Тилт
 1. A - 110, B - 68, C - 46, D - 50, E - 73 | 2. A - 42, B - 49, C - 43



Nixon Velvet

tkanina aksamit: Bluvel, kolor: antyczny róż 52 / metal, stal szcztokowa, mechanizm TILT
 velvet fabric: Bluvel, color: antique rose 52 / metal, brushed steel, TILT mechanism
 ткань бархат: Bluvel, цвет: античный розовый 52 / металл, матовая сталь, механизм Тилт
 A - 110, B - 68, C - 46, D - 50, E - 73 | A - 42, B - 49, C - 43



Hoover Velvet

tkanina aksamit: Bluvel, kolor: szary 14, pomarańczowy, tap. 179 / metal+drewno, kolor: czarny+dąb
 velvet fabric: Bluvel, color: grey 14, orange, up. 179 / metal+wood, color: black+oak
 ткань бархат: Bluvel, цвет: серый 14, оранжевый, об. 179 / металл+дерево, цвет: черный+дуб
 A - 106, B - 70, C - 54, D - 49, E - 80



Vesta Velvet

tkanina aksamit, kolor: szary, tap. 218
 velvet fabric, color: grey, up. 218
 ткань бархат, цвет: серый, об. 218
 A - 91, B - 78, C - 44, D - 50, E - 65, F - 24

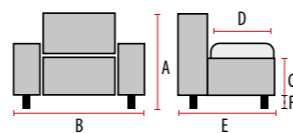

Focus Buffalo



Focus Buffalo

skóra syntetyczna: Buffalo, kolory: szary 06, oliwka 10 / metal, czarny mat
 synthetic leather: Buffalo, colors: grey 06, olive 10 / metal, black mat
 искусственная кожа: Buffalo, цвет: серый 06, оливковый 10 / металл, черный матовый
 A - 80, B - 70, C - 39, D - 47, E - 74, F - 24

Focus Brego ^N

tkanina: Brego, kolory: ciemny szary 18, beż 34 / metal, czarny mat
 fabric: Brego, colors: dark grey 18, beige 34 / metal, black mat
 ткань: Brego, цвет: темный серый 18, бежевый 34 / металл, черный матовый
 A - 80, B - 70, C - 39, D - 47, E - 74, F - 24



Clover Brego

tkanina: Brego, kolory: szary 07, curry 68 / metal, czarny mat
 fabric: Brego, colors: grey 07, curry 68 / metal, black mat
 ткань: Brego, цвет: серый 07, карри 68 / металл, черный матовый
 A - 71, B - 69, C - 44, D - 48, E - 68, F - 28

Cella Brego

tkanina: Brego, kolory: ciemny szary 18, oliwka 77, curry 68 / metal, czarny mat
 fabric: Brego, colors: dark grey 18, olive 77, curry 68 / metal, black mat
 ткань: Brego, цвет: темный серый 18, оливковый 77, карри 68 / металл, черный матовый
 A - 86, B - 73, C - 43, D - 52, E - 77, F - 31

NOWY KOLOR



Hades

fotel rozkładany, tkanina, kolor: szary, tap. 207
convertible armchair, fabric, color: grey, up. 207
раскладное кресло, ткань, цвет: серый, об. 207
A - 103, B - 88, C - 47, D - 57, E - 94+165, F - 6



Hades Velvet NOWY KOLOR

fotel rozkładany, tkanina aksamit: Bluvel, kolory: szary 14
convertible armchair, velvet fabric: Bluvel, colors: grey 14
раскладное кресло, ткань бархат: Bluvel, цвет: серый 14
A - 103, B - 88, C - 47, D - 57, E - 94+165, F - 6



Port USB

Tryb automatyczny:

- masaż całego ciała
- masaż odcinka szyjnego
- masaż odcinka lędźwiowego

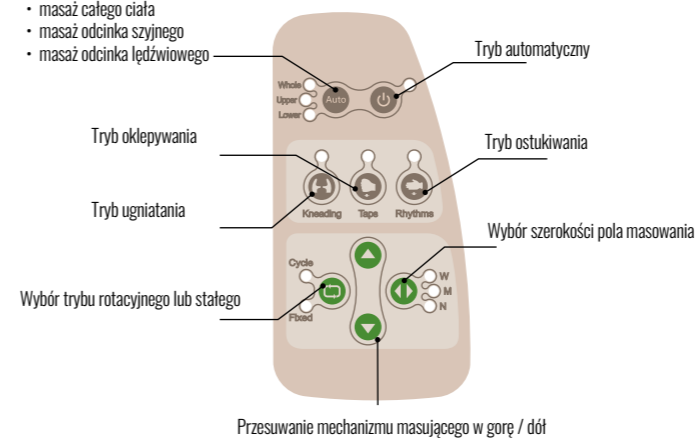

Uranos

fotel rozkładany elektrycznie, tkanina, kolor: szary, tap. 208, port USB
electric convertible armchair, fabric, color: grey, up. 208, USB port
электрическое раскладное кресло, ткань, цвет: серый, об. 208, USB-порт
A - 104, B - 75, C - 49, D - 56, E - 93+160, F - 8



Mars Velvet

fotel rozkładany, tkanina aksamit: Bluvel, kolor: szary 14
convertible armchair, velvet fabric: Bluvel, color: grey 14
раскладное кресло, ткань бархат: Bluvel, цвет: серый 14
A - 100, B - 75, C - 47, D - 53, E - 89+160

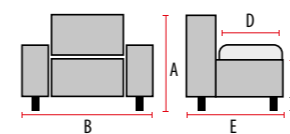

Bugatti MASSAGE FUNCTION

fotel masujący, skóra syntetyczna, kolory: beż, tap. 224 / brąz, tap. 225, szary, tap. 226 / czarny, tap. 227, port USB, uchwyt na kubek
armchair with massage function, synthetic leather, colors: beige, up. 224 / brown, up. 225, grey, up. 226 / black, up. 227, USB port, cup holder
массажное кресло, искусственная кожа, цвет: беж, об. 224 / коричневый, об. 225, серый, об. 226 / черный, об. 227, USB-порт, подстаканник
A - 95, B - 68, C - 42, D - 48, E - 92, F - 9



Zeus

fotel rozkładany, tkanina, kolor: brąz, tap. 159
convertible armchair, fabric, color: brown, up. 159
раскладное кресло, ткань, цвет: коричневый, об. 159
A - 108, B - 74, C - 47, D - 53, E - 93+165



Neron

fotel rozkładany, tkanina, kolor: szary, tap. 158
convertible armchair, fabric, color: grey, up. 158
раскладное кресло, ткань, цвет: серый, об. 158
A - 101, B - 72, C - 51, D - 55, E - 80+160



Notos

fotel rozkładany elektrycznie, skóra syntetyczna, kolory: beż, tap. 216, szary, tap. 217, port USB
convertible armchair, synthetic leather, colors: beige, up. 216, grey, up. 217, USB port
электрическое раскладное кресло, искусственная кожа, цвет: бежевый, об. 216, серый, об. 217, USB-порт
A - 116, B - 72, C - 49, D - 48, E - 83+160, F - 17



Zefir

fotel rozkładany elektrycznie, skóra syntetyczna, kolory: beż, tap. 215, szary, tap. 210, port USB
 electric convertible armchair, synthetic leather, colors: beige, up. 215, grey, up. 210, USB port
 электрическое раскладное кресло, искусственная кожа, цвет: беж, об. 215, серый, об. 210, USB-порт
 A - 106, B - 79, C - 50, D - 52, E - 101+160, F - 4



Zefir Velvet NOWY KOLOR

fotel rozkładany elektrycznie, tkanina aksamit: Bluvel, kolory: szary 14, beż 28, port USB
 electric convertible armchair, velvet fabric: Bluvel, colors: grey 14, beige 28, USB port
 электрическое раскладное кресло, ткань бархат: Bluvel, цвет: серый 14, бежевый 28, USB-порт
 A - 106, B - 79, C - 50, D - 52, E - 101+160, F - 4



Hektor M MASSAGE FUNCTION

fotel pionizujący rozkładany elektrycznie z funkcją masażu, skóra syntetyczna, kolory: czarny, tap. 209, szary, tap. 210
 convertible armchair with massage and lift function, synthetic leather, colors: black, up. 209, grey, up. 210
 электрическое массажное кресло, искусственная кожа, цвет: черный, об. 209, серый, об. 210
 A - 108, B - 89, C - 54, D - 52, E - 93+160, F - 4



Hektor M Velvet MASSAGE FUNCTION NOWY KOLOR

fotel pionizujący rozkładany elektrycznie z funkcją masażu, tkanina aksamit: Bluvel, kolory: szary 14, beż 28
 convertible armchair with massage and lift function, velvet fabric: Bluvel, colors: grey 14, beige 28
 электрическое массажное кресло, ткань бархат: Bluvel, цвет: серый 14, бежевый 28
 A - 108, B - 89, C - 54, D - 52, E - 93+160, F - 4



Helios M MASSAGE FUNCTION

fotel rozkładany elektrycznie z funkcją masażu i kotyjski, skóra syntetyczna, kolory: pomarańczowy, tap. 214, szary, tap. 210, port USB
 convertible rocking armchair with massage, synthetic leather, colors: orange, up. 214, grey, up. 210, USB port
 электрическое массажное кресло-качалка, искусственная кожа, цвет: оранжевый, об. 214, серый, об. 210, USB-порт
 A - 106, B - 89, C - 49, D - 51, E - 93+160, F - 4



Helios M Velvet MASSAGE FUNCTION NOWY KOLOR

fotel rozkładany elektrycznie z funkcją masażu i kotyjski, tkanina aksamit: Bluvel, kolory: szary 14, beż 28, port USB
 convertible rocking armchair with massage, velvet fabric: Bluvel, colors: grey 14, beige 28, USB port
 электрическое массажное кресло-качалка, ткань бархат: Bluvel, цвет: серый 14, бежевый 28, USB-порт
 A - 106, B - 89, C - 49, D - 51, E - 93+160, F - 4

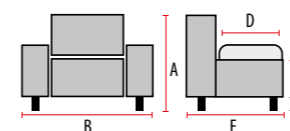



Otus Brego

fotel rozkładany, tkanina: Brego, kolory: ciemny szary 18, beż 34, oliwka 77
 convertible armchair, fabric: Brego, colors: dark grey 18, beige 34, olive 77
 раскладное кресло, ткань: Brego, цвет: темный серый 18, бежевый 34, оливковый 77
 A - 100, B - 66, C - 47, D - 53, E - 92-144, F - 5



NOWY KOLOR



NOWY KOLOR

Otus Velvet

fotel rozkładany, tkanina aksamit: Bluvel, kolory: szary 14, ciemny beż 40, zielony 78, czarny 19
 convertible armchair, velvet fabric: Bluvel, colors: grey 14, dark beige 40, green 78, black 19
 раскладное кресло, ткань бархат: Bluvel, цвет: серый 14, темный бежевый 40, зеленый 78, черный 19
 A - 100, B - 66, C - 47, D - 53, E - 92-144, F - 5



Otus II Velvet ^N

fotel pionizujący rozkładany elektrycznie, tkanina aksamit: Bluvel, kolory: szary 14, beż 28
 convertible armchair with lift function, velvet fabric: Bluvel, colors: grey 14, beige 28
 электрическое кресло, ткань бархат: Bluvel, цвет: серый 14, бежевый 28
 A - 100, B - 66, C - 47, D - 53, E - 92-144, F - 5



Otus II Brego ^N

fotel pionizujący rozkładany elektrycznie, tkanina: Brego, kolory: ciemny szary 18, beż 34
 convertible armchair with lift function, fabric: Brego, colors: dark grey 18, beige 34
 электрическое кресло, ткань: Brego, цвет: темный серый 18, бежевый 34
 A - 100, B - 66, C - 47, D - 53, E - 92-144, F - 5



Leto Velvet **N**

fotel pionizujący rozkładany elektrycznie, tkanina aksamit: Bluvel, kolory: szary 14, beż 28, czarny 19
 electric convertible armchair with lift function, velvet fabric: Bluvel, colors: grey 14, beige 28, black 19
 электрическое раскладное кресло, ткань бархат: Bluvel, цвет: серый 14, бежевый 28, черный 19
 A - 107, B - 68, C - 48, D - 51, E - 90-165



Adonis Velvet

fotel pionizujący rozkładany elektrycznie, tkanina aksamit: Bluvel, kolory: szary 14, ciemny beż 40, zielony 78, port USB, reg. zagłówek
 electric convertible armchair with lift function, velvet fabric: Bluvel, colors: grey 14, dark beige 40, green 78, USB port, adjustable headrest
 электрическое раскладное кресло, ткань бархат: Bluvel, цвет: серый 14, темный бежевый 40, зеленый 78, USB-порт, рег. подголовник
 A - 107, B - 77, C - 49, D - 54, E - 96-162



Leto Brego **N**

fotel pionizujący rozkładany elektrycznie, tkanina: Brego, kolory: ciemny szary 18, beż 34
 electric convertible armchair with lift function, fabric: Brego, colors: dark grey 18, beige 34
 электрическое раскладное кресло, ткань бархат: Brego, цвет: темный серый 18, бежевый 34
 A - 107, B - 68, C - 48, D - 51, E - 90-165



Adonis Buffalo

fotel pionizujący rozkładany elektrycznie, skóra syntetyczna: Buffalo, kolory: szary 06, oliwka 10, port USB, reg. zagłówek
 electric convertible armchair with lift function, synthetic leather: Buffalo, colors: grey 06, olive 10, USB port, adjustable headrest
 электрическое вертикальное раскладное кресло, искусственная кожа: Buffalo, цвет: серый 06, оливковый 10, USB-порт, рег. подголовник
 A - 107, B - 77, C - 49, D - 54, E - 96-162



funkcja kołyski
 rocking armchair

Jowisz Velvet

fotel rozkładany, tkanina aksamit: Bluvel, granatowy 86, regulowany zagłówek, funkcja bujania, reg. zagłówek
 convertible armchair, velvet fabric: Bluvel, dark blue 86, adjustable headrest, rocking function, adjustable headrest
 раскладное кресло качалка, ткань бархат: Bluvel, темный синий 86, рег. подголовник, рег. подголовник
 A - 102, B - 78, C - 46, D - 55, E - 98-160



Odys

fotel pionizujący rozkładany elektrycznie, tkanina, kolory: szary, tap. 198
 electric convertible armchair with lift function, fabric, colors: grey, up. 198
 электрическое раскладное кресло, ткань, цвет: серый, об. 198
 A - 103, B - 76, C - 48, D - 50, E - 93-162



Port USB

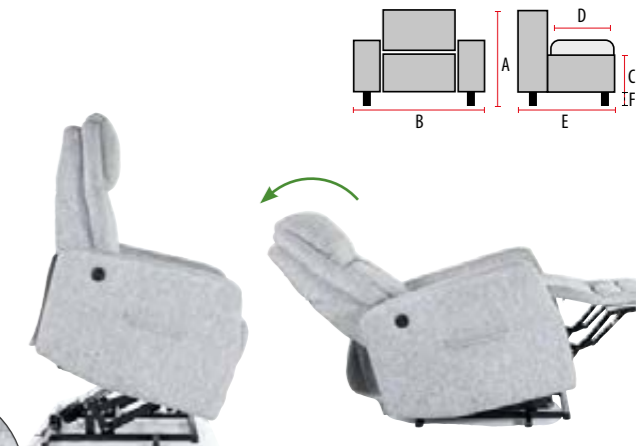

regulowany zagłówek
 adjustable headrest

Adonis

fotel pionizujący rozkładany elektrycznie, tkanina, tap. 178, kolor: szary, port USB, reg. zagłówek
 electric convertible armchair with lift function, fabric, up. 178, color: grey, USB port, adjustable headrest
 электрическое вертикальное раскладное кресло, ткань, об. 178, цвет: серый, USB-порт, рег. подголовник
 A - 107, B - 77, C - 49, D - 54, E - 96-162



NOWY KOLOR

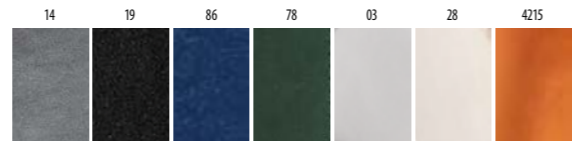

Neptun Velvet M MASSAGE FUNCTION NOWY KOLOR

fotel rozkładany elektrycznie z funkcją masażu i podgrzewania, tkanina aksamit: Bluvel, kolory: jasny szary 03, beż 28, cynamon 4215, granatowy 86, szary 14, zielony 78, czarny 19, port USB
 convertible armchair with massage and heating function, velvet fabric: Bluvel, colors: light grey 03, beige 28, cinnamon 4215, dark blue 86, grey 14, green 78, black 19, USB port
 раскладное массажное кресло, ткань бархат: Bluvel, цвет: светлый серый 03, бежевый 28, корица 4215, темный синий 86, серый 14, зеленый 78, черный 19, USB-порт
 A - 96, B - 76, C - 48, D - 57, E - 94+160



NOWY KOLOR

NOWY KOLOR

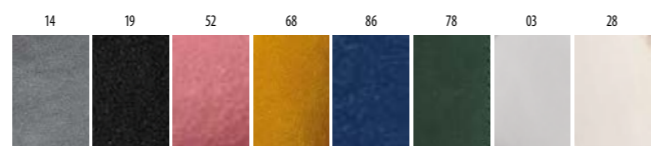

Neptun Velvet NOWY KOLOR

fotel rozkładany elektrycznie, tkanina aksamit: Bluvel, kolor: szary 14, antyczny róż 52, curry 68, zielony 78, jasny szary 03, granatowy 86, czarny 19, beż 28, port USB
 electric convertible armchair, velvet fabric: Bluvel, color: grey 14, antique rose 52, curry 68, green 78, light grey 03, dark blue 86, black 19, beige 28, USB port
 электрическое раскладное кресло, ткань бархат: Bluvel, цвет: серый 14, античный розовый 52, карри 68, зеленый 78, светлый серый 03, темный синий 86, черный 19, бежевый 28, USB-порт
 A - 96, B - 76, C - 48, D - 57, E - 94+160



Focus Buffalo



Port USB

Port USB

Neptun / Neptun M MASSAGE FUNCTION

fotel rozkładany elektrycznie (M - z funkcją masażu i podgrzewania), tkanina, tap. 178, kolor: szary, port USB
 convertible armchair (M - with massage and heating function), fabric, up. 178, color: grey, USB port
 электрическое раскладное (M- массажное с подогревом), ткань, об. 178, цвет: серый, USB-порт
 A - 96, B - 76, C - 48, D - 57, E - 94+160

Neptun Buffalo M MASSAGE FUNCTION

fotel rozkładany elektrycznie z funkcją masażu i podgrzewania, skóra syntetyczna: Buffalo, kolor: oliwka 10, port USB
 convertible armchair with massage and heating function, synthetic leather: Buffalo, color: olive 10, USB port
 электрическое массажное кресло с подогревом, искусственная кожа: Buffalo, цвет: оливковый 10, USB-порт
 A - 96, B - 76, C - 48, D - 57, E - 94+160



Olimp Velvet

fotel rozkładany z funkcją kołyski, tkanina aksamit: Bluvel, kolory: szary 14, curry 68, zielony 78, jasny szary 03, granatowy 86
 convertible rocking armchair, velvet fabric: Bluvel, colors: grey 14, curry 68, green 78, light grey 03, dark blue 86
 раскладное кресло-качалка, ткань бархат: Bluvel, цвет: серый 14, карри 68, зеленый 78, светлый серый 03, темный синий 86
 A - 101, B - 72, C - 51, D - 55, E - 80-160



Pegaz Velvet M

fotel rozkładany elektrycznie z funkcją masażu, tkanina aksamit: Bluvel, kolory: zielony 78, jasny szary 03, szary 14
 convertible armchair with massage function, velvet fabric: Bluvel, colors: green 78, light grey 03, grey 14
 раскладное массажное кресло, ткань бархат: Bluvel, цвет: зеленый 78, светлый серый 03, серый 14
 A - 102, B - 64, C - 47, D - 53, E - 88-160



Olimp Buffalo

fotel rozkładany z funkcją kołyski, skóra syntetyczna: Buffalo, kolory: szary 06, oliwka 10
 convertible rocking armchair, synthetic leather: Buffalo, colors: grey 06, olive 10
 раскладное кресло-качалка, искусственная кожа: Buffalo, цвет: серый 06, оливковый 10
 A - 101, B - 72, C - 51, D - 55, E - 80-160



Pegaz Buffalo

fotel rozkładany elektrycznie, skóra syntetyczna: Buffalo, kolory: szary 06, oliwka 10
 electric convertible armchair, synthetic leather: Buffalo, colors: grey 06, olive 10
 электрическое раскладное кресло, искусственная кожа: Buffalo, цвет: серый 06, оливковый 10
 A - 102, B - 64, C - 47, D - 53, E - 88-160



Olimp

fotel rozkładany z funkcją kołyski, tkanina, kolor: szary, tap. 178
 convertible rocking armchair, fabric, color: grey, up. 178
 раскладное кресло-качалка, ткань, цвет: серый, об. 178
 A - 101, B - 72, C - 51, D - 55, E - 80-160



Pegaz

fotel rozkładany elektrycznie, tkanina, kolor: szary, tap. 158
 convertible armchair, fabric, color: grey, up. 158
 раскладное кресло, ткань, цвет: серый, об. 158
 A - 102, B - 64, C - 47, D - 53, E - 88-160

Pegaz Velvet

fotel rozkładany elektrycznie, tkanina aksamit: Bluvel, kolory: beż 28, zielony 78, szary 14
 electric convertible armchair, velvet fabric: Bluvel, colors: beige 28, green 78, grey 14
 электрическое раскладное кресло, ткань бархат: Bluvel, цвет: бежевый 28, зеленый 78, серый 14
 A - 102, B - 64, C - 47, D - 53, E - 88-160



Port USB

Kronos Velvet

fotel rozkładany elektrycznie, tkanina aksamit: Bluvel, kolory: jasny szary 03, ciemny bez 40, cynamon 4215, port USB
 electric convertible armchair, velvet fabric: Bluvel, colors: light grey 03, dark beige 40, cinnamon 4215, USB port
 электрическое раскладное кресло, ткань бархат: Bluvel, цвет: светлый серый 03, темный бежевый 40, корица 4215, USB-порт
 A - 107, B - 79, C - 49, D - 53, E - 94+160



Port USB

Kronos

fotel rozkładany elektrycznie, tkanina, tap. 178, kolor: szary, port USB
 electric convertible armchair, fabric, up. 178, color: grey, USB port
 электрическое раскладное кресло, ткань, об. 178, цвет: серый, USB-порт
 A - 107, B - 79, C - 49, D - 53, E - 94+160

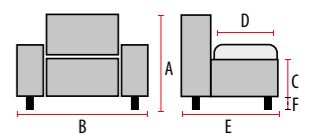

Ares Velvet

fotel rozkładany, tkanina aksamit: Bluvel, kolory: szary 14
 convertible armchair, velvet fabric: Bluvel, colors: grey 14
 раскладное кресло, ткань бархат: Bluvel, цвет: серый 14
 A - 100, B - 63, C - 45, D - 50, E - 76+150

Ares

fotel rozkładany, tkanina, kolor: szary, tap. 158
 convertible armchair, fabric, color: grey, up. 158
 раскладное кресло, ткань, цвет: серый, об. 158
 A - 100, B - 63, C - 45, D - 50, E - 76+150



beż 28 | beige 28

cynamon 4215 | cinnamon 4215

NOWY KOLOR curry 68

szary 14 | grey 14



jasny szary 03 | light grey 03

czarny 19 | black 19

NOWY KOLOR antyczny róż 52 | antique pink 52

oliwkowy 77 | olive 77

Carmen Velvet

fotel, tkanina aksamit: Bluelvel 03, 14, 19, 28, 52, 4215, 68, 77 / drewno, czarny mat armchair, velvet fabric: Bluelvel 03, 14, 19, 28, 52, 4215, 68, 77 / wood, black mat кресло, ткань бархат: Bluelvel 03, 14, 19, 28, 52, 4215, 68, 77 / древесина, черный матовый A - 99, B - 72, C - 46, D - 52, E - 75, F - 35



beż 40 | beige 40

szary 14 | grey 14

cynamon 4215 | cinnamon 4215

jasny szary 03 | light grey 03

Baron Velvet

tkanina aksamit: Bluelvel 03, 14, 28, 40, 4215, 52, 68, 78 / drewno, kolor: wenge velvet fabric: Bluelvel 03, 14, 28, 40, 4215, 52, 68, 78 / wood, color: wenge ткань бархат: Bluelvel 03, 14, 28, 40, 4215, 52, 68, 78 / древесина, цвет: венге A - 101, B - 75, C - 45, D - 53, E - 80, F - 12

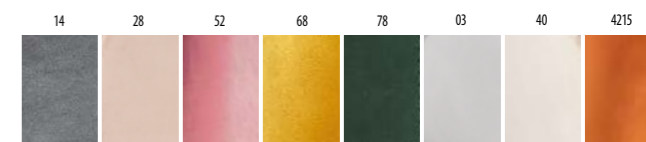



antyczny róż 52 | antique pink 52

jasny szary 03 | light grey 03

curry 68

cynamon 4215 | cinnamon 4215

Harry Velvet

fotel, tkanina aksamit: Bluvel 03, 14, 19, 28, 40, 4215, 68, 78, 86 / drewno, kolor: wenge
 armchair, velvet fabric: Bluvel 03, 14, 19, 28, 40, 4215, 68, 78, 86 / wood, color: wenge
 кресло, ткань бархат: Bluvel 03, 14, 19, 28, 40, 4215, 68, 78, 86 / древесина, цвет: венге
 A - 101, B - 82, C - 39, D - 57, E - 92, F - 12



Harry Velvet

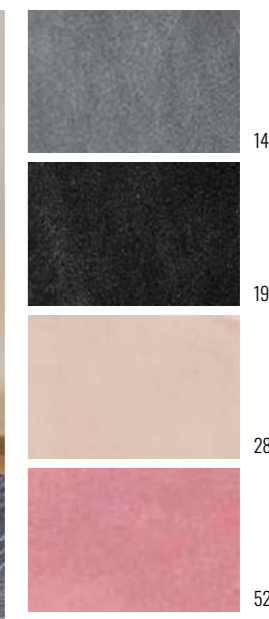

zielony 78 | green 78

cynamon 4215 | cinnamon 4215

czarny 19 | black 19

beż 28 | beige 28

Lady Velvet

fotel, tkanina aksamit: Bluvel 03, 14, 19, 28, 40, 4215, 52, 68, 78, 86 / drewno, kolor: wenge
 armchair, velvet fabric: Bluvel 03, 14, 19, 28, 40, 4215, 52, 68, 78, 86 / wood, color: wenge
 кресло, ткань бархат: Bluvel 03, 14, 19, 28, 40, 4215, 52, 68, 78, 86 / древесина, цвет: венге
 A - 101, B - 82, C - 39, D - 57, E - 92, F - 12



Lady Velvet

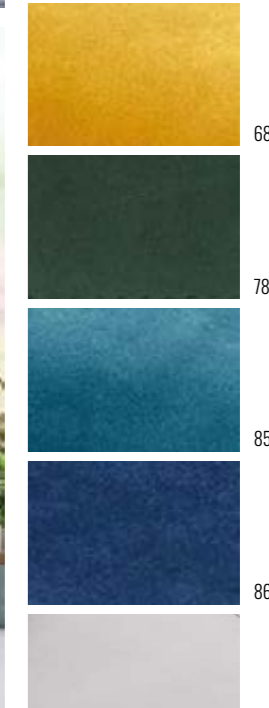

jasny szary 03 | light grey 03

cynamon 4215 | cinnamon 4215

Coral WM25

Coral WM82

Lord Coral / Lord Velvet

fotel, tkanina aksamit: Bluvel 03, 14, 28, 40, 4215, 68, 78, 85, 86, tkanina: Coral WM25, WM82 / drewno, kolor: wenge
 armchair, velvet fabric: Bluvel 03, 14, 28, 40, 4215, 68, 78, 85, 86, fabric: Coral WM25, WM82 / wood, color: wenge
 кресло, ткань бархат: Bluvel 03, 14, 28, 40, 4215, 68, 78, 85, 86, ткань: Coral WM25, WM82 / древесина, цвет: венге
 A - 101, B - 82, C - 39, D - 57, E - 92, F - 12



Lord Velvet

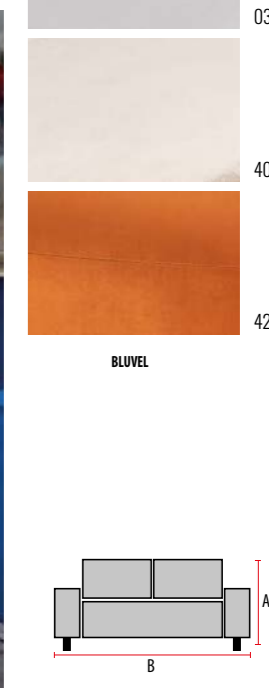



Karo Velvet



Kier Velvet



Nordic Velvet



Karo 2 Velvet

A - 76, B - 140, C - 42, D - 54, E - 75, F - 23



Karo 1 Velvet

A - 76, B - 78, C - 42, D - 54, E - 75, F - 23



Karo Velvet

tkanina aksamit: BLUVEL 03, 14, 40, 4215, 68, 78 / drewno, kolor: wenge, buk
velvet fabric: BLUVEL 03, 14, 40, 4215, 68, 78 / wood, color: wenge, beech
ткань бархат: BLUVEL 03, 14, 40, 4215, 68, 78 / древесина, цвет: венге, бук

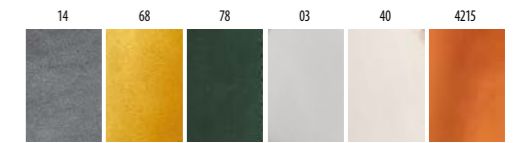

Kier 1 Velvet

A - 90, B - 76, C - 42, D - 55, E - 75, F - 23



Kier 2 Velvet

A - 90, B - 136, C - 42, D - 55, E - 75, F - 23

Kier Velvet

tkanina aksamit: BLUVEL 03, 14, 40, 4215, 68, 78 / drewno, kolor: wenge, buk
velvet fabric: BLUVEL 03, 14, 40, 4215, 68, 78 / wood, color: wenge, beech
ткань бархат: BLUVEL 03, 14, 40, 4215, 68, 78 / древесина, цвет: венге, бук

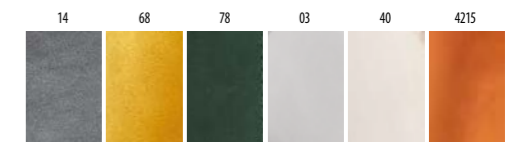

Nordic 3 Velvet

A - 90, B - 180, C - 42, D - 55, E - 75, F - 23



Nordic 2 Velvet

A - 90, B - 136, C - 42, D - 55, E - 75, F - 23

Nordic Velvet

tkanina aksamit: BLUVEL 14, 78, 86 / drewno, kolor: buk
velvet fabric: BLUVEL 14, 78, 86 / wood, color: beech
ткань бархат: BLUVEL 14, 78, 86 / древесина, цвет: бук

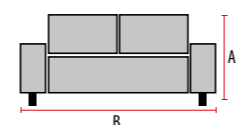
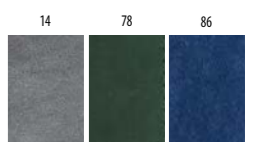

Nordic 1 Velvet

A - 90, B - 76, C - 42, D - 55, E - 75, F - 23



Castello Brego



Asprey Velvet



Castello 1 Velvet

A - 78, B - 92, C - 43, D - 60, E - 85, F - 15



Castello 2 Velvet

A - 78, B - 145, C - 43, D - 60, E - 85, F - 15



Castello 3 Velvet

1. A - 78, B - 200, C - 43, D - 60, E - 85, F - 15

Castello Velvet

tkanina aksamit: BLUVEL 03, 14, 19, 28, 40, 4215, 59, 68, 78, 86 / drewno, kolor: wenge
 velvet fabric: BLUVEL 03, 14, 19, 28, 40, 4215, 59, 68, 78, 86 / wood, color: wenge
 ткань бархат: BLUVEL 03, 14, 19, 28, 40, 4215, 59, 68, 78, 86 / древесина, цвет: венге

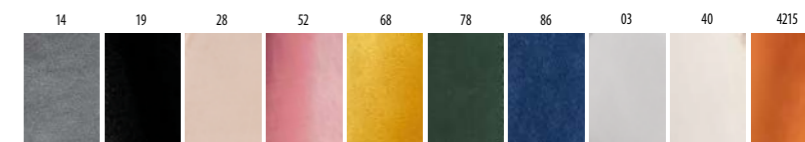

Castello 1 Brego ^N

A - 78, B - 92, C - 43, D - 60, E - 85, F - 15



Castello 3 Brego ^N

1. A - 78, B - 200, C - 43, D - 60, E - 85, F - 15

Castello Brego ^N

tkanina: Brego, kolory: szary 10, ciemny szary 18, beż 34, oliwka 77 / drewno, kolor: wenge
 fabric: Brego, colors: grey 10, dark grey 18, beige 34, olive 77 / wood, color: wenge
 ткань: Brego, цвет: серый 18, темный серый 18, бежевый 34, оливковый 77 / древесина, цвет: венге

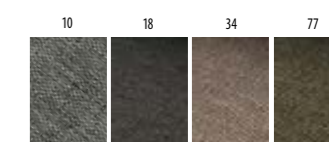

Castello 2 Brego ^N

A - 78, B - 145, C - 43, D - 60, E - 85, F - 15



Asprey 1 Velvet

A - 78, B - 83, C - 43, D - 60, E - 85, F - 18



Asprey 2 Velvet

A - 78, B - 150, C - 43, D - 60, E - 85, F - 18

Asprey Velvet

tkanina aksamit: BLUVEL 14, 68, 78, 86 / drewno, kolor: wenge
 velvet fabric: BLUVEL 14, 68, 78, 86 / wood, color: wenge
 ткань бархат: BLUVEL 14, 68, 78, 86 / древесина, цвет: венге

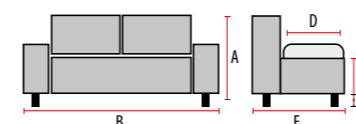
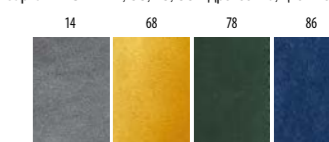



Molly Velvet



Molly 2 Velvet N

A - 83, B - 160, C - 43, D - 56, E - 85, F - 18



Molly 1 Velvet N

A - 83, B - 105, C - 43, D - 56, E - 85, F - 18



Molly Velvet N

tkanina aksamit: BLUVEL 14, 28, 40, 77 / drewno, kolor: wenge
velvet fabric: BLUVEL 14, 28, 40, 77 / wood, color: wenge
ткань бархат: BLUVEL BLUVEL 14, 28, 40, 77 / древесина, цвет: венге



Molly Brego



Molly 1 Brego N

A - 83, B - 105, C - 43, D - 56, E - 85, F - 18



Molly 2 Brego N

A - 83, B - 160, C - 43, D - 56, E - 85, F - 18

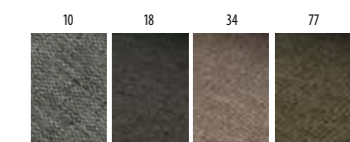

Molly Brego N

tkanina: Brego, kolory: szary 10, ciemny szary 18, beż 34, oliwka 77 / drewno, kolor: wenge
fabric: Brego, colors: grey 10, dark grey 18, beige 34, olive 77 / wood, color: wenge
ткань: Brego, цвет: серый 10, темный серый 18, бежевый 34, оливковый 77 / древесина, цвет: венге

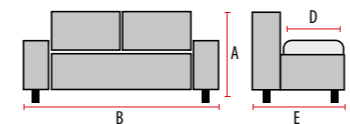



Elite Velvet



Elite 3 Velvet N

A - 83, B - 200, C - 43, D - 57, E - 85, F - 18



Elite 2 Velvet N

A - 83, B - 153, C - 43, D - 57, E - 85, F - 18



Elite 1 Velvet N

A - 83, B - 91, C - 43, D - 57, E - 85, F - 18



Elite Velvet N

tkanina aksamit: BLUVEL 14, 28, 40, 77 / drewno, kolor: wenge
 velvet fabric: BLUVEL 14, 28, 40, 77 / wood, color: wenge
 ткань бархат: BLUVEL BLUVEL 14, 28, 40, 77 / древесина, цвет: венге



Elite Brego



Elite 1 Brego N

A - 83, B - 105, C - 43, D - 56, E - 85, F - 18



Elite 2 Brego N

A - 83, B - 160, C - 43, D - 56, E - 85, F - 18

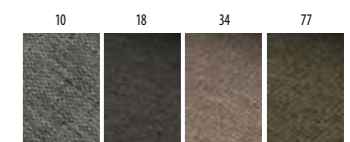

Elite Brego N

tkanina: Brego, kolory: szary 10, ciemny szary 18, beż 34, oliwka 77 / drewno, kolor: wenge
 fabric: Brego, colors: grey 10, dark grey 18, beige 34, olive 77 / wood, color: wenge
 ткань: Brego, цвет: серый 10, темный серый 18, бежевый 34, оливковый 77 / древесина, цвет: венге

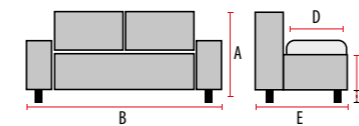



Camellia 1 Velvet

A - 77, B - 81, C - 44, D - 55, E - 76, F - 25



Camellia 2 Velvet

A - 77, B - 135, C - 44, D - 55, E - 76, F - 25

tkanina aksamit: Bluvel, szary 14, beż 28, czarny 19, antyczny róż 52 / metal, kolor: złoty
 velvet fabric: Bluvel, grey 14, beige 28, black 19, antique rose 52 / metal, color: golden
 ткань бархат: Bluvel, серый 14, бежевый 28, черный 19, античный розовый 52 / металл, цвет: золотой



Camellia Velvet



Camellia Velvet



Mena Velvet

tkanina aksamit: Bluvel kolory: jasny szary 03, szary 14, ciemny beż 40, cynamon 4215, zielony 78 / drewno, kolor: wenge
 velvet fabric: Bluvel, colors: light grey 03, grey 14, dark beige 40, cinnamon 4215, green 78 / wood, color: wenge
 ткань бархат: Bluvel, цвет: светлый серый 03, серый 14, т. бежевый 40, корица 4152, зеленый 78 / древесина, цвет: венге
 A - 85, B - 147, C - 52, D - 52, E - 75, F-23

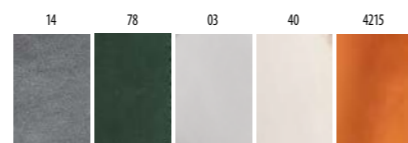

Flora Velvet

tkanina aksamit: Bluvel 14 / drewno, kolor: wenge
 velvet fabric: Bluvel 14 / wood, color: wenge
 ткань бархат: Bluvel 14 / древесина, цвет: венге
 A - 89, B - 129, C - 47, D - 46, E - 81, F-19

Darla Velvet

tkanina aksamit: Bluvel 14 / drewno, kolor: wenge
 velvet fabric: Bluvel 14 / wood, color: wenge
 ткань бархат: Bluvel 14 / древесина, цвет: венге
 A - 85, B - 139, C - 48, D - 50, E - 78, F-23

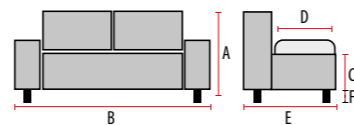

Mena Velvet



Gemma Velvet



Elsa Velvet

tkanina aksamit: Bluvel 14, 86 / drewno, kolor: wenge
sofa, velvet fabric: Bluvel 14, 86 / wood, color: wenge
диван, ткань бархат: Bluvel 14, 86 / древесина, цвет: венге
A - 80, B - 145, C - 45, D - 50, E - 75, F-23



Gemma Velvet

tkanina aksamit: Bluvel 14 / metal, kolor: czarny
velvet fabric: Bluvel 14 / metal, color: black
ткань бархат: Bluvel 14 / металл, цвет: черный
A - 86, B - 130, C - 48, D - 54, E - 75, F-23



TM-1 Velvet

tkanina aksamit: BLUVEL 03, 14, 19, 28, 40, 4215, 52, 68, 78, 85, 86
velvet fabric: BLUVEL 03, 14, 19, 28, 40, 4215, 52, 68, 78, 85, 86
ткань бархат: BLUVEL 03, 14, 19, 28, 40, 4215, 52, 68, 78, 85, 86
A - 76, B - 67, C - 41, D - 47, E - 60

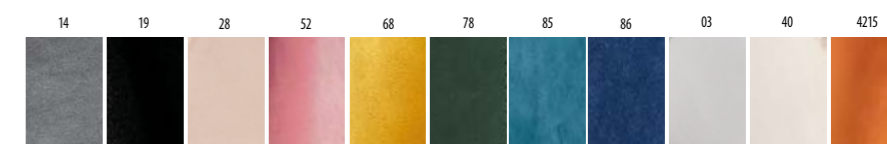

Elsa Velvet



TM-1

fotel, ekoskóra, kolor: według próbnika
armchair, eco leather, color: according to color swatch
кресло, экокожа, цвет: по образцу
A - 76, B - 67, C - 41, D - 47, E - 60



TM-2

sofa, ekoskóra, kolor: według próbnika
sofa, eco leather, color: according to color swatch
диван, экокожа, цвет: по образцу
A - 76, B - 126, C - 41, D - 47, E - 60

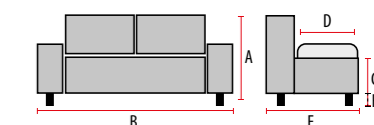

TM-3

sofa, ekoskóra, kolor: według próbnika
sofa, eco leather, color: according to color swatch
диван, экокожа, цвет: по образцу
A - 76, B - 160, C - 41, D - 47, E - 60



Spencer Velvet



Travis Velvet



Bluvel
szary 14 | grey 14

Buffalo
szary 06 | grey 06

Bjorn
szary 13 | grey 13

Spencer 1

fotel rozkładany, tkanina aksamit: Bluvel, tkanina: Bjorn, skóra syntetyczna: Buffalo
convertible armchair, fabric: Bjorn, velvet fabric: Bluvel, synthetic leather: Buffalo
раскладное кресло, ткань: Bjorn, velvet fabric: Bluvel, искусственная кожа: Buffalo
A - 101, B - 80, C - 48, D - 54, E - 94-164



Bluvel
szary 14 | grey 14

Buffalo
szary 06 | grey 06

Bjorn
szary 13 | grey 13

Spencer 2

sofa rozkładana, tkanina aksamit: Bluvel, tkanina: Bjorn, skóra syntetyczna: Buffalo
convertible sofa, fabric: Bjorn, velvet fabric: Bluvel, synthetic leather: Buffalo
раскладной диван, ткань: Bjorn, velvet fabric: Bluvel, искусственная кожа: Buffalo
A - 101, B - 136, C - 48, D - 54, E - 94-164



Bluvel
szary 14 | grey 14

Buffalo
szary 06 | grey 06

Bjorn
szary 13 | grey 13

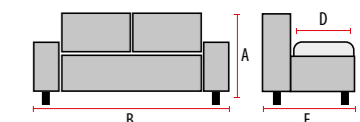

Spencer 3

sofa rozkładana, tkanina aksamit: Bluvel, tkanina: Bjorn, skóra syntetyczna: Buffalo, rozkładane skrajne 2 siedzenia
convertible sofa, fabric: Bjorn, velvet fabric: Bluvel, synthetic leather: Buffalo foldable outer seats
раскладной диван, ткань: Bjorn, velvet fabric: Bluvel, искусственная кожа: Buffalo складные внешние сиденья
A - 101, B - 193, C - 48, D - 54, E - 94-164



szary 14 | grey 14

ciemny beż 40 | dark beige 40

Travis 1 Velvet

fotel rozkładany, tkanina aksamit: Bluelvel, kolory: szary 14, ciemny beż 40
 convertible armchair, velvet fabric: Bluelvel, colors: grey 14, dark beige 40
 раскладное кресло, ткань бархат: Bluelvel, цвет: серый 14, темный бежевый 40
 A - 102, B - 72, C - 48, D - 53, E - 86x164, F - 5



Billy / Billy Velvet

fotel rozkładany, kolor: szary, tap. 137; tkanina aksamit: szary, tap. 139, niebieski, tap. 188 / drewno, kolor: buk
 convertible chair, color: grey, up. 137; velvet fabric: grey, up. 139, blue, up. 188 / wood, color: beech
 раскладное кресло, цвет: серый, об. 137; ткань бархат: серый, об. 139, синий, об. 188 / древесина, цвет: бук
 A - 82, B - 103, C - 42, D - 58, E - 94, F - 103x191



ciemny beż 40 | dark beige 40

szary 14 | grey 14

Travis 2 Velvet

sofa rozkładana, tkanina aksamit: Bluelvel, kolory: szary 14, ciemny beż 40
 convertible sofa, velvet fabric: Bluelvel, colors: grey 14, dark beige 40
 раскладной диван, ткань бархат: Bluelvel, цвет: серый 14, темный бежевый 40
 A - 102, B - 127, C - 48, D - 53, E - 86x164, F - 5



Willy

sofa rozkładana, kolor: szary, tap. 137 / drewno, kolor: buk
 convertible sofa, color: grey, up. 137 / wood, color: beech
 раскладной диван, цвет: серый, об. 137 / древесина, цвет: бук
 A - 82, B - 132, C - 39, D - 52, E - 91, F - 125x191



szary 14 | grey 14

ciemny beż 40 | dark beige 40

Travis 3 Velvet

sofa rozkładana, tkanina aksamit: Bluelvel, kolory: szary 14, ciemny beż 40, rozkładane skrajne 2 siedzenia
 convertible sofa, velvet fabric: Bluelvel, colors: grey 14, dark beige 40, foldable outer seats
 раскладной диван, ткань бархат: Bluelvel, цвет: серый 14, темный бежевый 40, складные внешние сиденья
 A - 102, B - 182, C - 48, D - 53, E - 86x164, F - 5

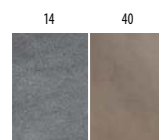

BLUVEL



Zenia / Zenia Velvet

fotel rozkładany, kolor: szary, tap. 137; tkanina aksamit: zielony, tap. 189 / drewno, kolor: buk
 convertible chair, color: grey, up. 137; velvet fabric: green, up. 189 / wood, color: beech
 раскладное кресло, цвет: серый, об. 137; ткань бархат: зеленый, об. 189 / древесина, цвет: бук
 A - 82, B - 103, C - 42, D - 58, E - 94, F - 103x191





tap. 197

tap. 139

tap. 182

tap. 188

NOWY KOLOR



tap. 137

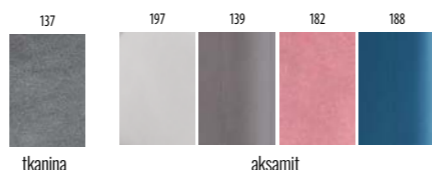

tkanina

aksamit

Spike / Spike Velvet

fotel rozkładany, tkanina: szary, tap. 137, tkanina aksamit: jasny szary, tap. 197, szary, tap. 139, antyczny róż, tap. 182, niebieski, tap. 188 / drewno, kolor: buk
 convertible sofa, fabric: grey, up. 137, velvet fabric: light grey, up. 197, grey, up. 139, antique rose, up. 182, blue, up. 188 / wood, color: beech
 раскладное кресло, ткань: серый, об. 137, ткань бархат: светлый серый, об. 197, серый, об. 139, античный розовый, об. 182, синий, об. 188 / древесина, цвет: бук
 A - 80, B - 105, C - 39, D - 63, E - 90, F - 105x190



Spencer



tap. 138

tap. 189

tap. 139

NOWY KOLOR



tap. 137



tap. 188

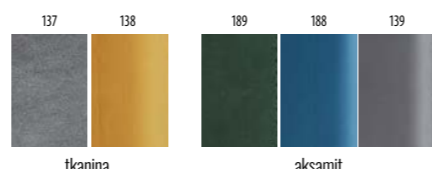

tkanina

aksamit

Spike II / Spike II Velvet

sofa rozkładana, tkanina: szary, tap. 137, curry, tap. 138, tkanina aksamit: zielony, tap. 189, niebieski, tap. 188, szary, tap. 139 / drewno, kolor: buk
 convertible sofa, fabric: grey, up. 137, curry, up. 138, velvet fabric: green, up. 189, blue, up. 188, grey, up. 139 / wood, color: beech
 раскладной диван, ткань: серый, об. 137, карри, об. 138, ткань бархат: зеленый, об. 189, синий, об. 188, серый, об. 139 / древесина, цвет: бук
 A - 84, B - 147, C - 42, D - 50, E - 91, F - 148x193



Spencer II Velvet



Sophia Velvet 60 40

puf, tkanina aksamit: Bluelvel 03, 14, 19, 40, 77
 pouf, velvet fabric: Bluelvel 03, 14, 19, 40, 77
 пуф, ткань бархат: Bluelvel 03, 14, 19, 40, 77



Ron Velvet 40 60 44

podnózek bez pojemnika, tkanina aksamit: Bluelvel 03, 14, 19, 28, 40, 4015, 52, 68, 78, 86 / drewno, kolor: wenge
 footstool without storage without storage, velvet fabric: Bluelvel 03, 14, 19, 28, 40, 4015, 52, 68, 78, 86 / wood, color: wenge
 подставка для ног без контейнера, ткань бархат: Bluelvel 03, 14, 19, 28, 40, 4015, 52, 68, 78, 86 / древесина, цвет: венге



Lori Velvet 39 39 34

puf, tkanina aksamit: Bluelvel 03, 14, 19, 28, 40, 4215, 52, 68, 78, 85, 86
 pouf, velvet fabric: Bluelvel 03, 14, 19, 28, 40, 4215, 52, 68, 78, 85, 86
 пуф, ткань бархат: Bluelvel 03, 14, 19, 28, 40, 4215, 52, 68, 78, 85, 86



Lori 2 Velvet 39 76 34

puf, tkanina aksamit: Bluelvel 03, 14, 19, 28, 40, 4215, 52, 68, 78, 85, 86
 pouf, velvet fabric: Bluelvel 03, 14, 19, 28, 40, 4215, 52, 68, 78, 85, 86
 пуф, ткань бархат: Bluelvel 03, 14, 19, 28, 40, 4215, 52, 68, 78, 85, 86

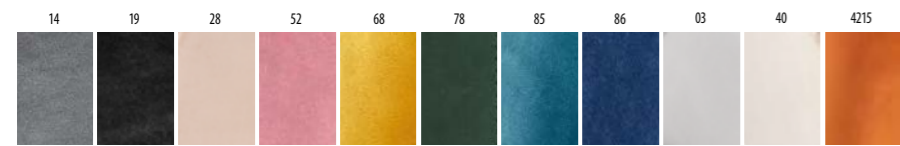

BLUVEL



Hestia Velvet 50 100 46

puf, tkanina aksamit: Bluelvel 03, 14, 19, 28, 52, 68, 78, 86
 pouf, velvet fabric: Bluelvel 03, 14, 19, 28, 52, 68, 78, 86
 пуф, ткань бархат: Bluelvel 03, 14, 19, 28, 52, 68, 78, 86



Hestia K Velvet 50 50 46

puf, tkanina aksamit: Bluelvel 03, 14, 19, 28, 52, 68, 78, 86
 pouf, velvet fabric: Bluelvel 03, 14, 19, 28, 52, 68, 78, 86
 пуф, ткань бархат: Bluelvel 03, 14, 19, 28, 52, 68, 78, 86



Flo Raven 39 76 34

puf, tkanina Raven, kolor: szary, tap. 06, ciemny beż, tap. 28
 pouf, fabric Raven, color: gray, up. 06, dark beige, up. 286
 пуф, ткань Raven, цвет: серый, об. 06, темный бежевый, об. 28



Festina I 30 99 45

ławka / bench / скамья
 tkanina aksamit, kolor: czarny, tap. 105 / stal nierdzewna, kolor: srebrny
 velvet fabric, color: black, up. 105 / stainless steel, color: silver
 ткань бархат, цвет: черный, об. 105 / нерж. сталь, цвет: серебряный



Onyx 46 100 48

ławka / bench / скамья
 tkanina aksamit, kolor: czarny, tap. 105 / stal nierdzewna, kolor: srebrny
 velvet fabric, color: black, up. 105 / stainless steel, color: silver
 ткань бархат, цвет: черный, об. 105 / нерж. сталь, цвет: серебряный



Noir 46 100 48

ławka / bench / скамья
 tkanina aksamit, kolor: czarny, tap. 105 / stal nierdzewna, kolor: złoty
 velvet fabric, color: black, up. 105 / stainless steel, color: golden
 ткань бархат, цвет: черный, об. 105 / нерж. сталь, цвет: золотой



Engine

obraz na szkle / glass print / картина на стекле, 120x80



Yacht

obraz na szkle / glass print / картина на стекле, 120x80



Dubai

obraz na szkle / glass print / картина на стекле, 120x80



Cappadocia

obraz na szkle / glass print / картина на стекле, 120x80



Street View I

obraz na szkle / glass print / картина на стекле, 120x80



Venice

obraz na szkle / glass print / картина на стекле, 120x80



Golden Tide

obraz na szkle / glass print / картина на стекле, 120x80



Sea View

obraz na szkle / glass print / картина на стекле, 120x80



Trees I

obraz na szkle / glass print / картина на стекле, 120x80



Penguins

obraz na szkle / glass print / картина на стекле, 120x80



Horses

obraz na szkle / glass print / картина на стекле, 120x80



Elephant

obraz na szkle / glass print / картина на стекле, 120x80



Golden Face

obraz na szkle / glass print / картина на стекле, 120x80



Avatar

obraz na szkle / glass print / картина на стекле, 120x80



Butterfly

obraz na szkle / glass print / картина на стекле, 120x80

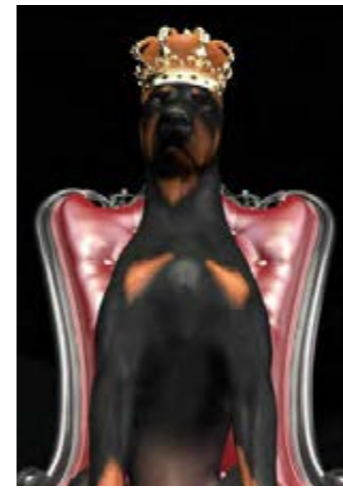

Dog in Crown

obraz na szkle / glass print / картина на стекле, 80x120



Angel

obraz na szkle / glass print / картина на стекле, 80x120



Hongkong

obraz na szkle / glass print / картина на стекле, 160x60



Flower Woman I

obraz na szkle / glass print / картина на стекле, 80x120



Flower Woman II

obraz na szkle / glass print / картина на стекле, 80x120



Skull I

obraz na szkle / glass print / картина на стекле, 80x120



Skull II

obraz na szkle / glass print / картина на стекле, 80x120



Flowers III

obraz na szkle / glass print / картина на стекле, 80x80



Flowers I

obraz na szkle / glass print / картина на стекле, 120x80

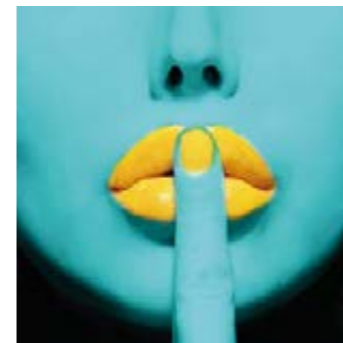

Lips

obraz na szkle / glass print / картина на стекле, 80x80



Casanova

obraz na szkle / glass print / картина на стекле, 120x80

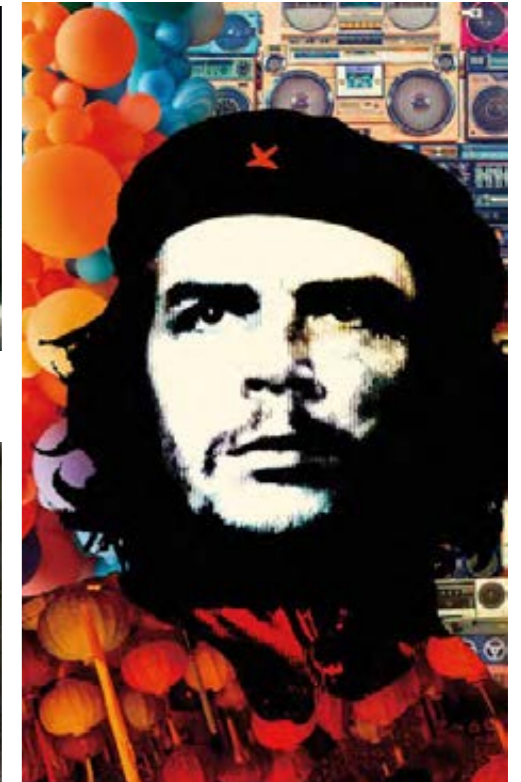

Ernesto

obraz na szkle / glass print / картина на стекле, 80x120

Indeks alfabetyczny

A

Acoma	230, 245
Acoma Velvet	245
Adam	94, 95
Adonis	267
Adonis Buffalo	267
Adonis Velvet	267
Afra	129
Agat Velvet	169
Agava	139
Agis	57, 79
Agis A	57, 115
Agis II	51
Alabama	191
Alan Brego	164
Alan Velvet	164
Alaras III	33
Albin	216
Aldo Brego	165
Alessia	252
Alfie Velvet	249
Allen	219
Almeria A	128
Almeria B	128
Almond	139
Aloe	176
Alta A	135
Alta B	135
Alto	73
Alto II	73
Amadeo	81
Amadeo II	81
Amaro	121
Amber A	131
Amber B	131
Angel	60, 299
Antila	124
Apollo	49
Apple Velvet	154
April Vardo	181
Arco Brego	177
Arco Velvet	177
Ares	273
Ares Velvet	273
Ariana B	112
Aries	109
Arizona Velvet	191
Armani	33
Armani Ceramic	33
Artemida	125
Ascot	234
Aspen	235
Aspen II Velvet	233
Aspen Velvet	232, 233, 246
Asprey 1 Velvet	281
Asprey 2 Velvet	281
Aster	71
Asti Brego	162
Aston	17
Astoria II Velvet	158
Atena	124
Atlanta A	120
Atlanta A II	120
Atlanta B	120
Atlanta B II	120
Atlanta C	120
Atlanta C II	120
Atlanta D	120
Atlanta D II	120
Atlanta III	121
Atom Velvet	179
August Velvet	186
Ava A	215
Ava B	215
Avangard II Ceramic	5
Avatar	298
Axo Brego	181
Axo Velvet	181
Azalia	55
Azalia Brego	149
Azalia Buffalo	149
Azalia Ceramic	55, 113
Azalia Velvet	149
Azuro Velvet	228, 244, 254

B

B-005	205
B-07	206
B-011	205
B-012	205
B-013	205

B-021	205
B-027	206
B-036	206
B-168	206
B-202	206
B-216	206
B-219	206
B-233	206
Bahama	133
Bali	143
Bali II	143
Ballo Brego	159
Barcelona	235
Bari	47
Baron Velvet	275
Basil Vardo	146
Beata	141
Bella Velvet	247
Belmont Raven	225
Ben	176
Berry Brego	181
Betty	257
Billy	293
Billy Velvet	293
Birma	254
Bolonia	237, 254
Bono Velvet	55, 161
Bonucci Ceramic	31
Boogie I Velvet	150
Boogie II Velvet	150
Bora C	137
Brando	45, 185
Brick	43
Brigitte Brego	257
Bronson	218
BT-001	102
BT-002	102
BT-005	102
BT-006	102
BT-007	102
Bugatti	261
Butterfly	298

C

C-105 Velvet	188
C-617	188
Cactus	219
Calabria Velvet	223
California D	141
Calipso	85, 138
Calvin	57
Camaro	200
Camellia 1 Velvet	286
Camellia 2 Velvet	286
Capitol	27
Cappadocia	298
Capri Vardo	159
Carlo A	130
Carmen Velvet	275
Carven Velvet	221
Casanova	299
Castello 1 Brego	281
Castello 1 Velvet	281
Castello 2 Brego	281
Castello 2 Velvet	281
Castello 3 Brego	281
Castello 3 Velvet	281
CD-56	185
CD-57	185
CD-61	185
CD-964	189
Cella Brego	259
Ceres	57
Cherry Bjorn	157
Cherry Buffalo	156
Cherry H-1 Velvet	188
Cherry H-2 Velvet	188
Cherry II Velvet	172
Cherry Matt Velvet	157
Cherry Monolith	157
Cherry Velvet	157
Chic Brego	170
Chic Chrom Velvet	171
Chic D Velvet	171
Chic H-1 Velvet	188
Chic H-2 Velvet	188
Chic Matt Velvet	171
Chic Velvet	170
Chic Zloty Velvet	171
Chloe Velvet	241
Clark	112

Cleo	137
Clover Brego	259
Cobe Velvet	173
Coco I Vardo	150
Coco II Vardo	150
Coda Vardo	162
Colin B H-2 Velvet	189
Colin B Velvet	172
Colt	71
Columbia Velvet	226
Columbus Ceramic	29
Combo	212
Cono dąb / Cono laminat	75
Cono laminat	75
Consul	193
Corner	212
Corral A	143
Corso Vardo	165
Cortez Ceramic	35
Cosmic	217
Costa A	211
Costa B	211
Cotto	139
Crocus	89, 138
Cross	41
Crystal A	113
Crystal B	113
Cyprus A	108
Cyprus B	108
Cyryl I	51
Cyryl II	79

D

Dafne	138
Daisy	202
Dakar	201
Dallas	37
Damar	98
Dan	176
Daniel	141
Dante	91
Darta Velvet	286
Delia II	126
Dello	105
Demeter	124
Demeter II	124
Denis	219
Devon	194
Diego II	93
Dion	122
Diuna	7
Diuna Ceramic	7, 9
Doblo	123
Dog in Crown	299
Dolce Ceramic	31
Dolores B	137
Dolores C	137
Domingo	65
Domingo II	65
Dual	123
Dubai	298
Duke	219

E

Ego	184
Egoa	138
Electra Velvet	233
Elephant	298
Eliot Velvet	250
Elise A	118
Elise B	118
Elise C	118
Elise S	118
Elite 1 Brego	285
Elite 1 Velvet	285
Elite 2 Brego	285
Elite 2 Velvet	285
Elite 3 Velvet	285
Ella A	133
Ella B	133
Ellis Bjorn	165
Elmo Velvet	248
Elsa Velvet	289
Elton	161
Emotion Velvet	222
Engine	298
Envo A	135
Eos B	127
Eos C	127
Eos D	127
Eos E	127

Epi	136
Ergon	194
Eris	218
Ernesto	299
Escada A	118, 119
Escada A II	118, 119
Escada A III	119
Escada B	118, 119
Escada B II	118, 119
Escada B III	119
Escada C	119
Escada C II	118
Espero	57, 81
Espero II	81
ET-001	255
ET-002	255
ET-003	255
ET-920	254
Hermes	138
Exel	87

F

Fabia C	136
Falcon	41
Felicia Raven	257
Ferrante B	121
Ferrante C	121
Ferrante D	121
Ferrante E	121
Ferro	219
Festina I	297
Fiesta	93
Fig Velvet	154
Finezja A	51
Fiord	93
Flame B	116
Flame C	116
Flip	91
Lou	183
Irene	140
Irys Velvet	178
Itaka	111
Italia	124, 125
Italia II	124
Ivo Velvet	164
Ivy	49

J

Jadeit	255
Jake Nea	167
Jerry Velvet	167
Jill Velvet	173
Fossil C	117
Foster	216
Fox	178
Jowisz Velvet	266

K

Kansas	191
Karina A	129
Karina B	129
Karl	76, 185
Karo 1 Velvet	279
Karo 2 Velvet	279
Kayla Velvet	173
Ken Brego	184
Kent	83
Kenzie Bjorn	162
Kenzo A	113
Kenzo C	113
Kevin Vardo	173
Kier 1 Velvet	279
Kier 2 Velvet	279
Kim Velvet	169
King Velvet	54, 186
Kleopatra	141
Klif Bjorn	165
Kora B	134
Kora C	134
Kora D	134
Molly 1 Velvet	283
Molly 2 Brego	283
Molly 2 Velvet	283
Mona	111
Monako Velvet	221, 254
Moncler Ceramic	7
Peggie	257
Penelope	124, 125
Ponguis	298
Peterson Ceramic	3
Piano B H-2 Velvet	189
Piano B Matt Velvet	175
Mosso I	93
Mosso II	76
Mosso III	93
Planet Raven	146
Muna	136
Murano	59

L

Lady Velvet	276
Lagos A	131
Lagos B	131
Laguna A	133
Laguna B	133
Lanta	252
Lanta Velvet	253

H-261 chrom	183
H-261 Velvet	183
H-441	182
H-441 material	182
H-441 Velvet	182
H-733 Gandar	183
Hades	260
Hades Velvet	219
Harmony A	130
Harmony B	130
Harmony C	130
Harper	257
Harper	257
Harry Velvet	276
Hektor M	262
Hektor Velvet M	263
Helios M	262
Helios M Velvet	263
Linea 54	54
Herron	217
Herrera Velvet	221
Hestia K Velvet	297
Hestia Velvet	297
Hill	109
Hilton C	119
Hola	122
Hongkong	299
Hoover Velvet	258
Horacy	91
Horses	298
Houston	89
Hugo Brego	146

I

Ibiza C	126
Ideal	79
Infinity Ceramic	5
Into	123
Lou	183
Lugo	216
Luna	73
Lunaria	129

M

M1	255
M2	255
Madras	51
Maison Velvet	236
Mango Vardo	159
Mango Velvet	159
Marani Velvet	236
Marea	138
Margo	105
Marina	138
Mars Velvet	260
Maryland	191
Matis A	207
Matis B	207
Matrix	212
Mena Velvet	286
Merida B	129
Merida C	129
Merlin	39
Metro	41
Metro Bjorn	144
Metro H-1	189
Metropol Ceramic	35
Mike Nea	167
Mila D Velvet	174
Mila H-2 Velvet	189
Mila Matt Velvet	174
Milan S2	137
Kim Velvet	137
Mila Velvet	174
Milos	126
Mirage Velvet	222, 241
MN-SC	185
Molly 1 Brego	283
Molly 1 Velvet	283
Molly 2 Brego	283
Molly 2 Velvet	283
Mona	111
Monako Velvet	221, 254
Moncler Ceramic	7
Peggie	257
Penelope	124, 125
Ponguis	298
Peterson Ceramic	3
Piano B H-2 Velvet	189
Piano B Matt Velvet	175
Mosso I	93
Mosso II	76
Mosso III	93
Planet Raven	146
Muna	136
Murano	59

Largo C	131
Largo Duo	129
Larson	76
Lemon Velvet	154
Leo	109
Leonardo	37
Leta	108
Napa A	108
Napa B	108
Nelson	76, 185
Neptun	269
Neptun M	269
Neptun Buffalo M	269
Neptun Velvet	268
Neptun Velvet M	268
Neron	260
Net A	209
Net B	209
Nevada D	141
Nevio	83
Next	85
Nigel	85
Nikoja Raven	224
Nixon Velvet	258
Noel	212
Noir	297
Nordic 1 Velvet	279
Nordic 2 Velvet	279
Nordic 3 Velvet	279
Norte Velvet	161
Notos	261
Notti Brego	144
Nova	216
Nova II	216
Nova II Bis	216
Nuvo Velvet	161
Nuxe Velvet	158

O

Oakland	73
Odys	266
Olimp	270
Olimp Buffalo	270
Olimp Velvet	270
Olivia	105
Olsen A	207
Onyx	297
Opera	76
OP-SC 2	185
Oregon	191
Orfe Sztruks	177
Orfe Velvet	177
Orion	129
Osaka A	128
Osaka B	128
Osaka C	128
Oslo L2	137
Oslo S2	137
Otis	218
Ottavia A	113
Ottavia B	113
Otus Brego	264
Otus Velvet	264
Otus II Brego	265
Otus II Velvet	264

P

P-006	214
P-007	214
P-013	214
Padova C	141
Padova D	141
Palermo I	128
Palermo II	128
Pallas Ceramic	35
Pam A	135
Pam B	135
Pegaz	271

Stoły



Adam
s. 94, s. 95



Agis
s., 57, 79



Agis
s. 79



Agis II
s. 51



Alaras III
s. 33



Alto
s. 73



Alto II
s. 73



Amadeo
s. 81



Amadeo II
s. 81



Angel
s. 60



Apollo
s. 49



Armani
s. 33



Armani Ceramic
s. 33



Armani Ceramic
s. 33



Aster
s. 71



Aston
s. 17



Avangard II Ceramic
s. 5



Azalia
s. 55



BT-001
s. 102



BT-002
s. 102



BT-005
s. 102



BT-006
s. 102



BT-007
s. 102



Bari
s. 47



Bonucci Ceramic
s. 47



Brando
s. 45



Brick
s. 43



Calipso
s. 85



Calipso
s. 85



Calvin
s. 57



Capitol
s. 27



Ceres
s. 57



Colt
s. 71



Colt
s. 71



Columbus Ceramic
s. 29



Cono
s. 75



Cortez Ceramic
s. 35



Crocus
s. 89



Cross
s. 41



Cyril I
s. 51



Cyril II
s. 79



Dallas
s. 37



Damar
s. 98



Damar
s. 98



Dante
s. 91



Dello
s. 105



Diego II
s. 93



Diuna Ceramic
s. 9



Diuna
s. 7



Dolce Ceramic
s. 31



Domingo
s. 65



Domingo II
s. 65



Espero
s. 81



Espero
s. 81



Espero II
s. 81



Exel
s. 87



Falcon
s. 41



Fiesta
s. 93



Finezza A
s. 51



Fiord
s. 93



Flip
s. 91



Fresno
s. 43



Fresno dąb
s. 43



Galant
s. 101



Galaxy
s. 65

A-Z

A-Z



Gaston
s. 67



GD-017
s. 101



GD-017
s. 97



GD-017
s. 97



GD-020
s. 101



Moncler Ceramic
s. 7



Nelson
s. 76



Nevio
s. 83



Next
s. 85



Nigel
s. 85



GD-082
s. 97



GD-082
s. 97



Genesis
s. 29



Giotto
s. 39



Hermes
s. 54



Oakland
s. 73



Olivia
s. 105



Opera
s. 76



Pallas Ceramic
s. 35



Peterson Ceramic
s. 3



Horacy
s. 91



Houston
s. 89



Ideal
s. 79



Infinity Ceramic
s. 5



Infinity Ceramic
s. 5



Platon
s. 89



Porto Ceramic
s. 59



Porto Ceramic
s. 59



Presto
s. 91



Prince Ceramic
s. 52



Ivy
s. 49



John
s. 49



Karl
s. 76



Kent
s. 83



Prince
s. 53



Pub
s. 102



Pub H
s. 102



Pub K
s. 102



Puro
s. 102



Larson
s. 76



Leonardo
s. 37



Logan
s. 27



Logan Ceramic
s. 27



Loreto Ceramic
s. 3



Puro II
s. 102



Remus
s. 45



Remus II
s. 45



Rene
s. 47



Rion
s. 49



Luna
s. 73



Madras
s. 51



Margo
s. 105



Merlin
s. 39



Metro
s. 41



Ritmo
s. 75



Rolf
s. 51



Salvadore
s. 23, 25



Salvadore Ceramic
s. 21, 23, 25



Salvadore Ceramic II
s. 25



Metropol Ceramic
s. 35



Mosso I
s. 93



Mosso II
s. 76



Mosso III
s. 93



Murano
s. 59



Samanta Ceramic
s. 3



Samuel
s. 51



Saturn II Ceramic
s. 35



Socrates
s. 62



Sorento Ceramic
s. 17



Sorento Ceramic
s.17



Syriusz
s.87



Talia
s.69



Talia II
s.69



Tampa
s.83



Tetis
s.71



Tibi
s.93



Timber
s.45



Umberto
s.41



Umberto II
s.39



Vento
s.83



Vidar
s.87



Vito
s.43



Westin I
s.15



Westin III Ceramic
s.13



Westin Ceramic
s.13,15



Westin SC
s.17



Westin SG
s.15



Wilson
s.3



Xaviero II
s.39

Ławy



Afra
s.129



Agava
s.139



Agis A
s.115



Agis A
s.115



Almond
s.139



Almeria A
s.128



Almeria B
s.128



Alta B
s.135



Alta A
s.135



Amaro
s.121



Amaro
s.121



Amber A
s.131



Amber B
s.131



Antila
s.124



Ariana B
s.112



Artemida
s.125



Aries
s.109



Atena
s.124



Atlanta A
s.120



Atlanta A II
s.120



Atlanta B
s.120



Atlanta B II
s.120



Atlanta C
s.120



Atlanta C II
s.120



Atlanta D
s.120

A-Z

307



Atlanta D II
s. 120



Atlanta III
s. 121



Atlanta III
s. 121



Azalia Ceramic
s. 113



Bahama
s. 133



Ella A
s. 133



Ella B
s. 133



Egoa
s. 138



Envo A
s. 135



Eos B
s. 127



Beata
s. 141



Bora C
s. 137



California D
s. 141



Calipso
s. 138



Carlo A
s. 130



Eos C
s. 127



Eos D
s. 127



Eos D
s. 127



Eos D
s. 127



Eos E
s. 127



Clark
s. 112



Cleo
s. 137



Cotto
s. 139



Cotto
s. 139



Crocus
s. 138



Eos E
s. 127



Eos E
s. 127



Epi
s. 136



Escada A
s. 119



Escada A
s. 119



Crystal A
s. 113



Crystal B
s. 113



Cyprus A
s. 108



Cyprus B
s. 108



Daniel
s. 141



Escada A II
s. 118



Escada A II
s. 119



Escada A II
s. 118



Escada A III
s. 119



Escada B
s. 118



Dafne
s. 138



Delia II
s. 126



Demeter
s. 124



Demeter II
s. 124



Dolores B
s. 137



Escada B II
s. 119



Escada B II
s. 118



Escada B II
s. 118



Escada B III
s. 119



Escada C II
s. 118



Dolores C
s. 137



Dion
s. 122



Dion
s. 122



Dion
s. 122



Dion
s. 122



Escada C II
s. 118



Escada C II
s. 118



Evita
s. 138



Fabia C
s. 136



Ferrante B
s. 121



Doblo
s. 123



Dual
s. 123



Elise A
s. 118



Elise B
s. 118



Elise C / S
s. 118



Ferrante C
s. 121



Ferrante D
s. 121



Ferrante E
s. 121



Flame B
s. 116



Flame C
s. 116

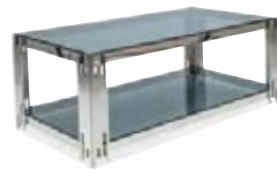

Fossil A
s. 117



Fossil B
s. 117



Fossil C
s. 117



Gema
s. 138



Gemini
s. 109



Laguna A
s. 133



Laguna B
s. 133



Largo C
s. 131



Largo Duo
s. 129



Leo
s. 109



Gloria II
s. 136



Gloria II
s. 136



Gloria
s. 114



Gina B
s. 126



Harmony A
s. 130



Lex L
s. 129



Lex S
s. 129



Libra
s. 108

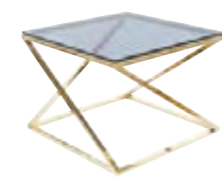

Liam
s. 114



Lisa II
s. 140



Harmony B
s. 130



Harmony C
s. 130



Hill
s. 109



Hola
s. 122



Hola
s. 122



Lisa Basic II
s. 140



Lisa D
s. 140



Livia
s. 112



Livia
s. 112



Liz II
s. 131



Hola
s. 122



Hola
s. 122



Hola
s. 122



Hilton C
s. 119



Ibiza C
s. 126



Lunaria
s. 129



Marea
s. 138



Marina
s. 138



Merida B
s. 129



Merida C
s. 129



Irene
s. 140



Italia
s. 125



Italia
s. 124



Italia II
s. 124



Into
s. 123



Milan S2
s. 137



Milos
s. 126



Mona
s. 111



Mona
s. 111



Muna
s. 136



Itaka
s. 111



Karina A
s. 129



Karina B
s. 129



Kenzo A
s. 113



Kenzo C
s. 113



Muse
s. 114



Muse II
s. 114



Mystic B
s. 126



Nevada D
s. 141



Napa A
s. 108



Kleopatra
s. 141



Kora
s. 134



Kron
s. 135



Lagos A
s. 131



Lagos B
s. 131



Napa B
s. 108



Orion
s. 129



Osaka A
s. 128



Osaka B
s. 128



Osaka C
s. 128



Oslo L2
s. 137



Oslo S2
s. 137



Ottavia A
s. 113



Ottavia B
s. 113



Padova C
s. 141



Sabine
s. 141



Sabine
s. 141



Saga
s. 126



Salma
s. 114



Salva
s. 126



Padova D
s. 141



Palermo I
s. 128



Palermo II
s. 128



Pam A
s. 135



Pam B
s. 135



Scarlet
s. 126



Scarlet
s. 126



Scarlet II
s. 126



Scarlet II
s. 126



Seti
s. 109



Penelope
s. 124



Penelope
s. 124



Penelope
s. 125



Platon
s. 138



Polaris
s. 131



Silver A
s. 115



Silver A
s. 115



Silver A
s. 115



Silver A
s. 115



Silver A II
s. 115



Polo
s. 135



Portafino A
s. 114



Portafino B
s. 114



Priam A
s. 140



Prima A
s. 133



Silver B
s. 115



Silver B
s. 115



Silver B II
s. 115



Step
s. 134



Step
s. 134



Prima B
s. 133



Prince A
s. 117



Prince B
s. 117



Prince C
s. 117



Prince A Ceramic
s. 117



Symphony A
s. 131



Symphony B
s. 131



Symphony C
s. 131



Symphony D
s. 131



Symphony G
s. 136



Prince B Ceramic
s. 117



Prince C Ceramic
s. 117



Quadra
s. 138



Ravello
s. 128



Rava C
s. 140



Taurus
s. 109



Tiffany A
s. 110



Tiffany A
s. 110



Tiffany B
s. 110



Tiffany B
s. 110



Rodos
s. 111



Rossi A
s. 128



Rossi B
s. 128



Rossi C
s. 128



Royal D
s. 141



Trinity
s. 136



Tuca
s. 133



Twin
s. 135



Twin
s. 135



Twingo
s. 123

A-Z

A-Z



Twix
s. 123



Wendy B
s. 131



Vanessa
s. 128



Vega B
s. 137



Vega C
s. 137



Vela A
s. 116



Vela B
s. 116



Versace C
s. 116



Vetro
s. 134



Vicky
s. 136



Vienna
s. 113



Vienna
s. 113



Virgo
s. 108



Zegna A
s. 119



Zegna B
s. 119



Zegna C
s. 119

Fotele obrotowe



Alabama
s. 191



Arizona Velvet
s. 191



Camaro
s. 200



Consul
s. 193



Daisy
s. 202



Dakar
s. 201



Devon
s. 194



Ergon
s. 194



Kansas
s. 191



Maryland
s. 191



Oregon
s. 191



Q-019
s. 202



Q-020 Velvet
s. 204



Q-022
s. 204



Q-022 material
s. 204



Q-022 Velvet
s. 204



Q-025
s. 197



Q-025 Material
s. 197



Q-026
s. 197



Q-031
s. 192



Q-033
s. 201



Q-035
s. 196



Q-036
s. 193



Q-046
s. 193



Q-052
s. 193

A-Z

315

314



Q-058
s. 195



Q-060
s. 194



Q-078
s. 197



Q-083
s. 202



Q-087
s. 192



Q-346
s. 196



Q-406
s. 195



Q-409
s. 195



Q-557
s. 193



Q-639
s. 194



Q-087 material
s. 192



Q-095
s. 195



Q-118
s. 195



Q-118R
s. 195



Q-121
s. 202



Q-861
s. 196



Q-886 Velvet
s. 203



Q-904
s. 193



Q-939
s. 201



Q-G2
s. 203



Q-136
s. 197



Q-154
s. 192



Q-190
s. 203



Q-211
s. 196



Q-229
s. 201



Rapid
s. 201



Revolt
s. 201



Rose Velvet
s. 202



Vermont
s. 191



Viper
s. 200



Q-270
s. 192



Q-278
s. 192



Q-288
s. 202



Q-289
s. 202



Q-306
s. 193



Zenvo
s. 201



Q-319
s. 197



Q-320
s. 198



Q-320R
s. 198



Q-328
s. 199



Q-328H
s. 199



Q-330
s. 198



Q-330R
s. 198



Q-333
s. 199



Q-336
s. 196



Q-345
s. 196

Wzorniki Tkanin

BLUVEL

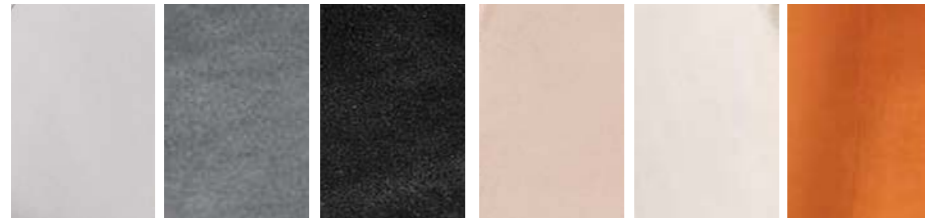

03 14 19 28 40 4215

BLUVEL

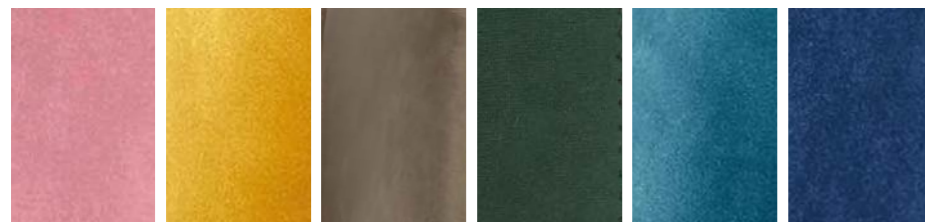

52 68 77 78 85 86

BREGO



07 10 18 31 34 68 77 86 90 93

BJORN

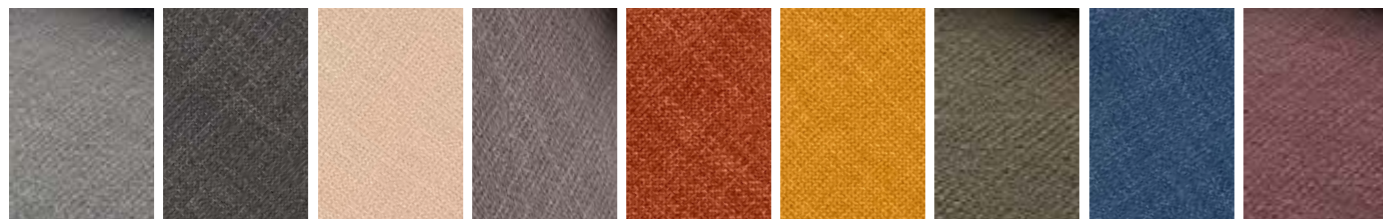

13 16 34 24 42 68 77 86 99

BUFFALO

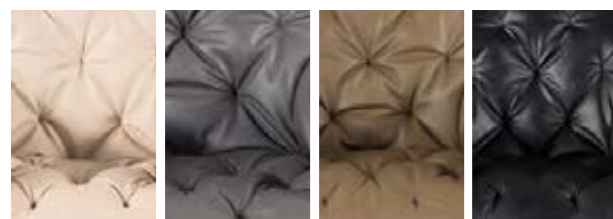

01 06 10 11

RAVEN



06 18 22 28 44

VARDO



11 19 34 35 42 66 74 89

NEA



07 19 27 56 66 77 86

EKOSKÓRA

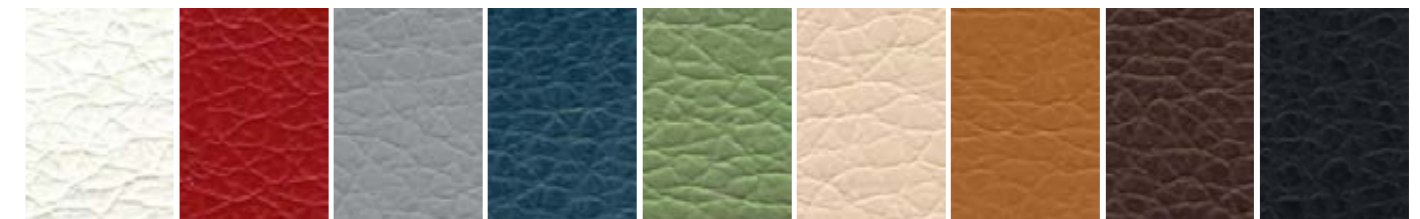

biały czerwony szary granatowy zielony krem jasny brąz ciemny brąz czarny

FJORD

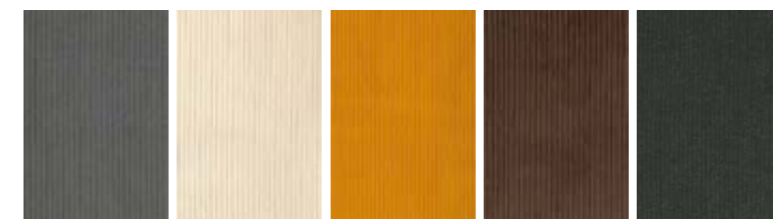

15 23 66 47 79



SIGNAL
meble

SIGNAL MEBLE sp. z o.o. sp.k.

ul. Kilińskiego 35 B, 27-400 Ostrowiec Świętokrzyski

tel (+48) 41 247 94 44, e-mail: signal@signal.pl

Dział handlowy:

tel. (+48) 41 247 94 62, e-mail: meble@signal.pl

Dział exportu:

tel. (+48) 41 249 44 79, e-mail: export@signal.pl

Dział reklamacji:

tel. (+48) 41 249 44 87, (+48) 41 249 44 88, e-mail: reklamacje@signal.pl

www.signal.pl

Niniejszy katalog nie stanowi oferty handlowej w rozumieniu Kodeksu Cywilnego i jest publikacją jedynie w celach informacyjnych. Zdjęcia i kolory zamieszczone w katalogu mogą odbiegać od wzorów produktów znajdujących się w sprzedaży. Firma Signal zastrzega sobie prawo do zmian technicznych i wizualnych służących ulepszeniu produktu oraz możliwości pomyłek i błędów w druku. Przedmioty i meble użyte do aranżacji a nie wyszczególnione w opisach technicznych nie stanowią oferty handlowej firmy SIGNAL.

This catalogue is not a commercial offer and it is made only to inform. Pictures and colours can be different from models we sell. SIGNAL company reserves the right to visual and technical changes which improve products and possibility of making mistakes and misprints. Objects and furniture used to arrangement which are not specified in technical descriptions, are not a commercial offer SIGNAL company.

Нижеследующий каталог не является торговым предложением и составлен только с целью передачи информации. Фотографии и цвета присутствующие в каталоге могут не соответствовать образцам продуктов в продаже. Фирма Сигнал оставляет за собой право вносить технические и визуальные изменения для улучшения продукта а также возможности ошибок в распечатке. Предметы и мебель использованные к фотографиям не перечислены в техническом описании каталога не являются торговым предложением фирмы SIGNAL.



SIGNAL
meble

Ostrowiec Świętokrzyski, ul. Kilińskiego 35b
tel (+48) 41 247 94 62
e-mail: meble@signal.pl



www.signal.pl

